

MC2: Evolution and Future of Synchrotron Radiation Sources

RIKEN SPring-8 Center

Hitoshi TANAKA

2026/05/16@Deauville

1. History of synchrotron radiation source development
2. Diffraction-limited SR sources
3. Single-pass free-electron lasers
4. Future development direction with a few topics

Brilliance enhancement over the past century

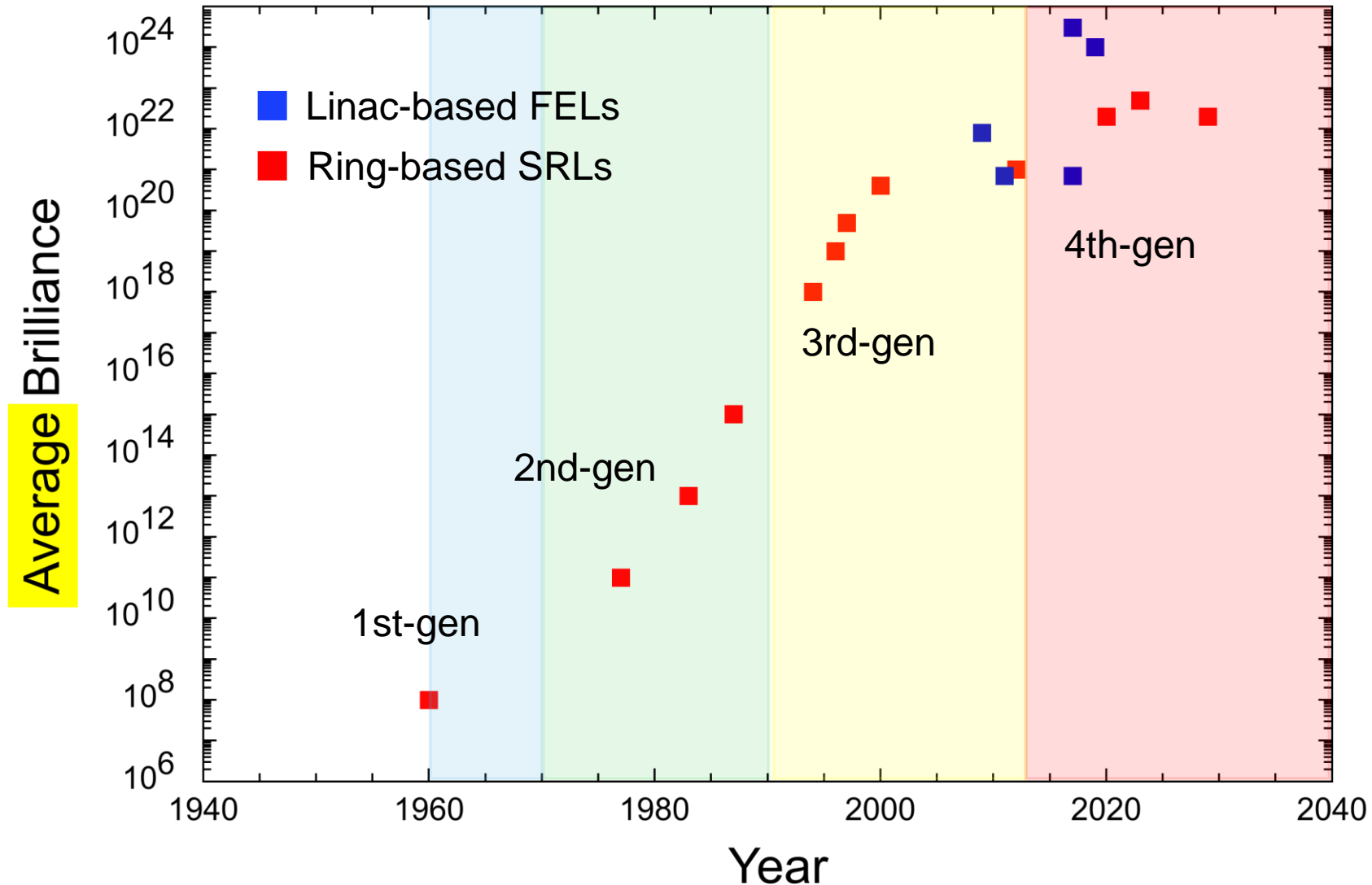

Brilliance enhancement over the past century

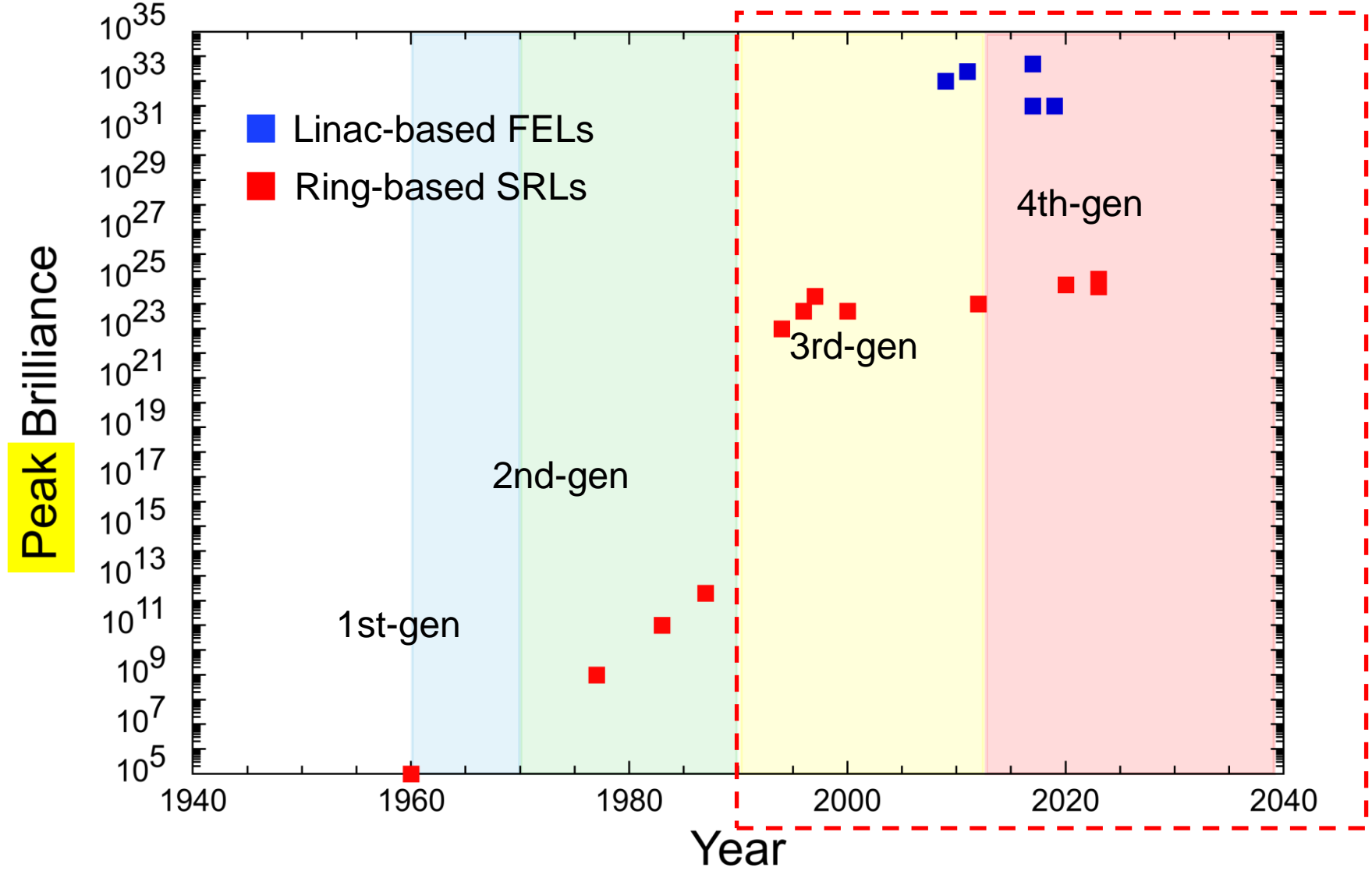

Recent evolution of SR sources

Performance index: Brilliance

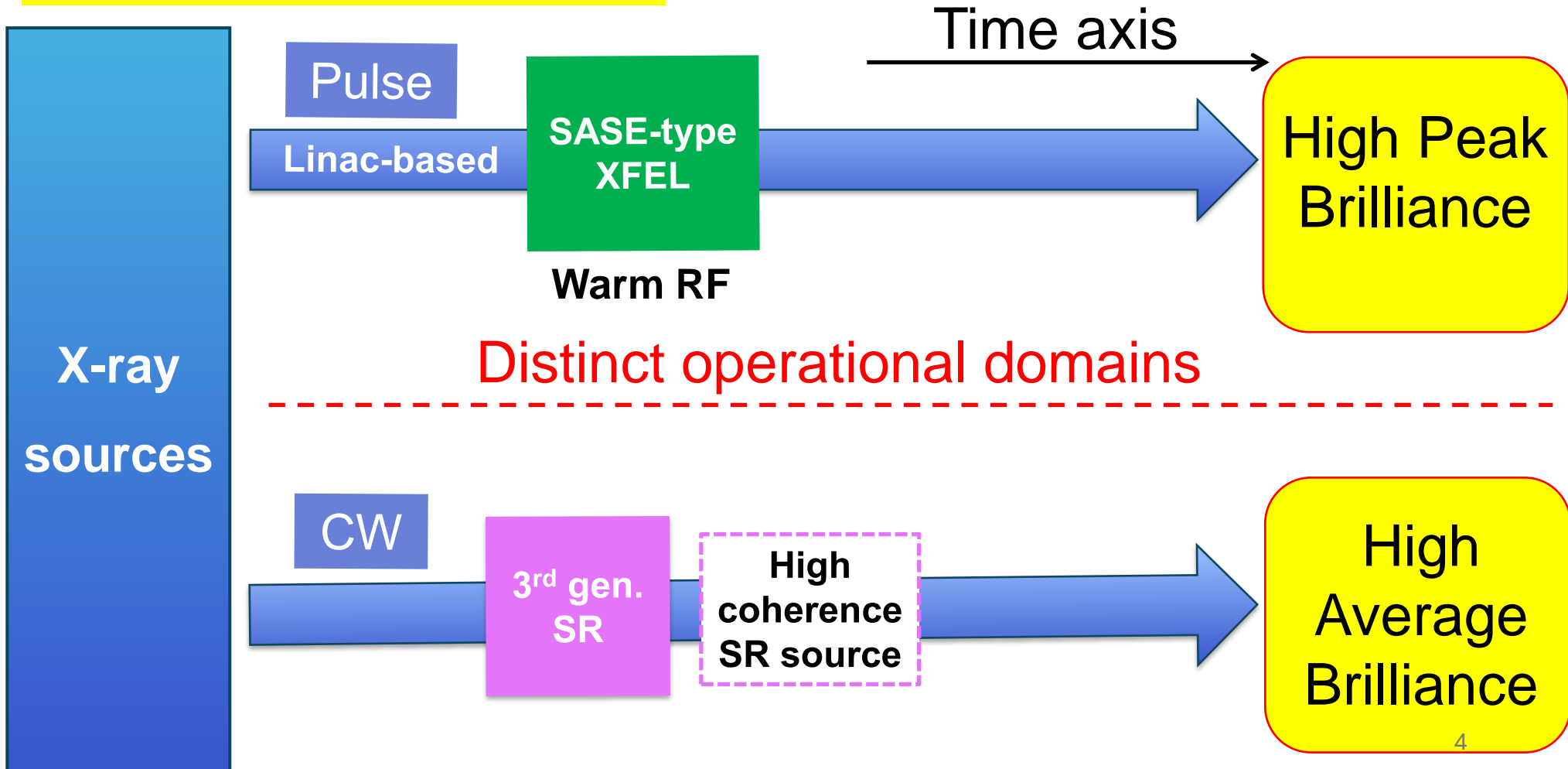

Recent evolution of SR sources

Performance index: Brilliance

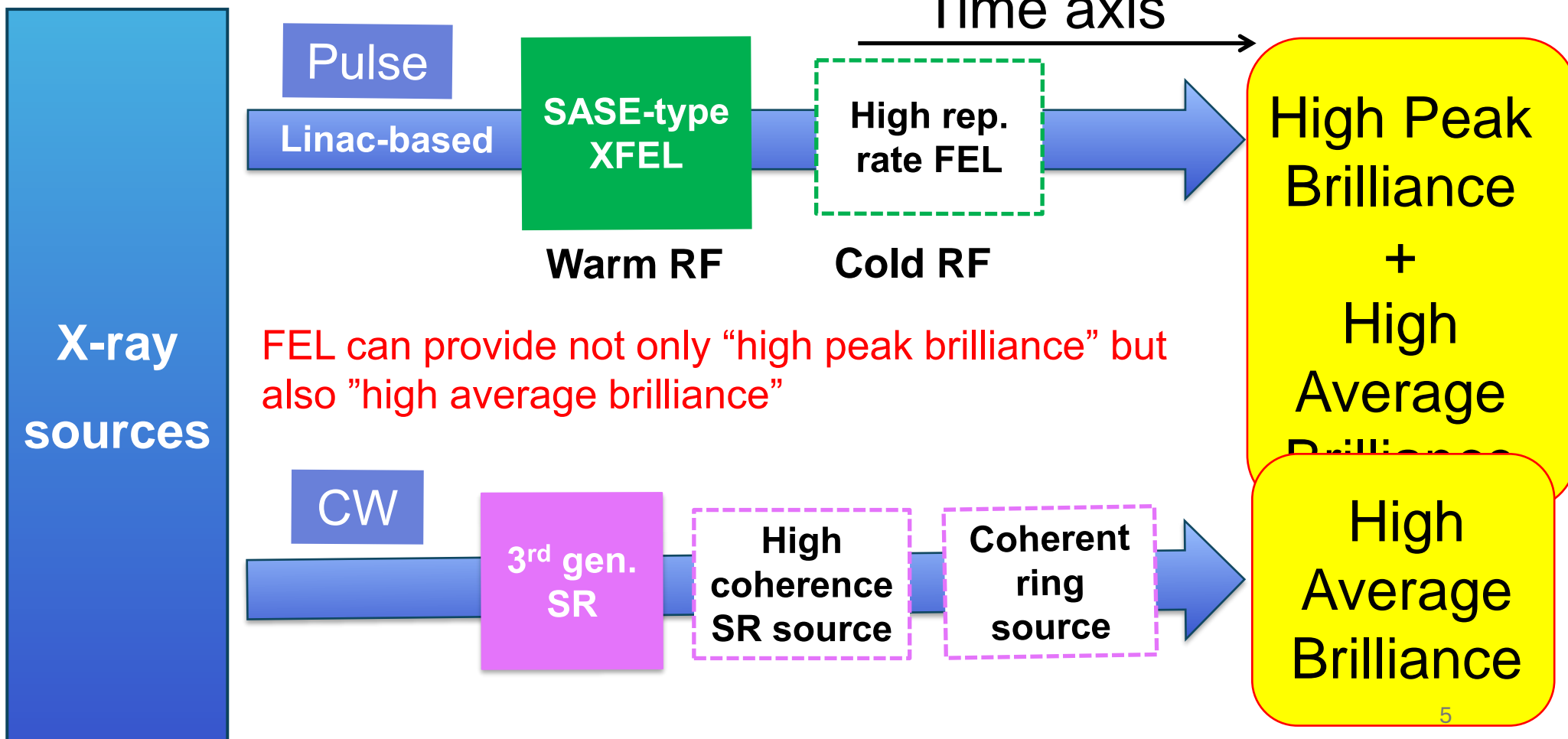

Recent evolution of SR sources

Performance index: Brilliance

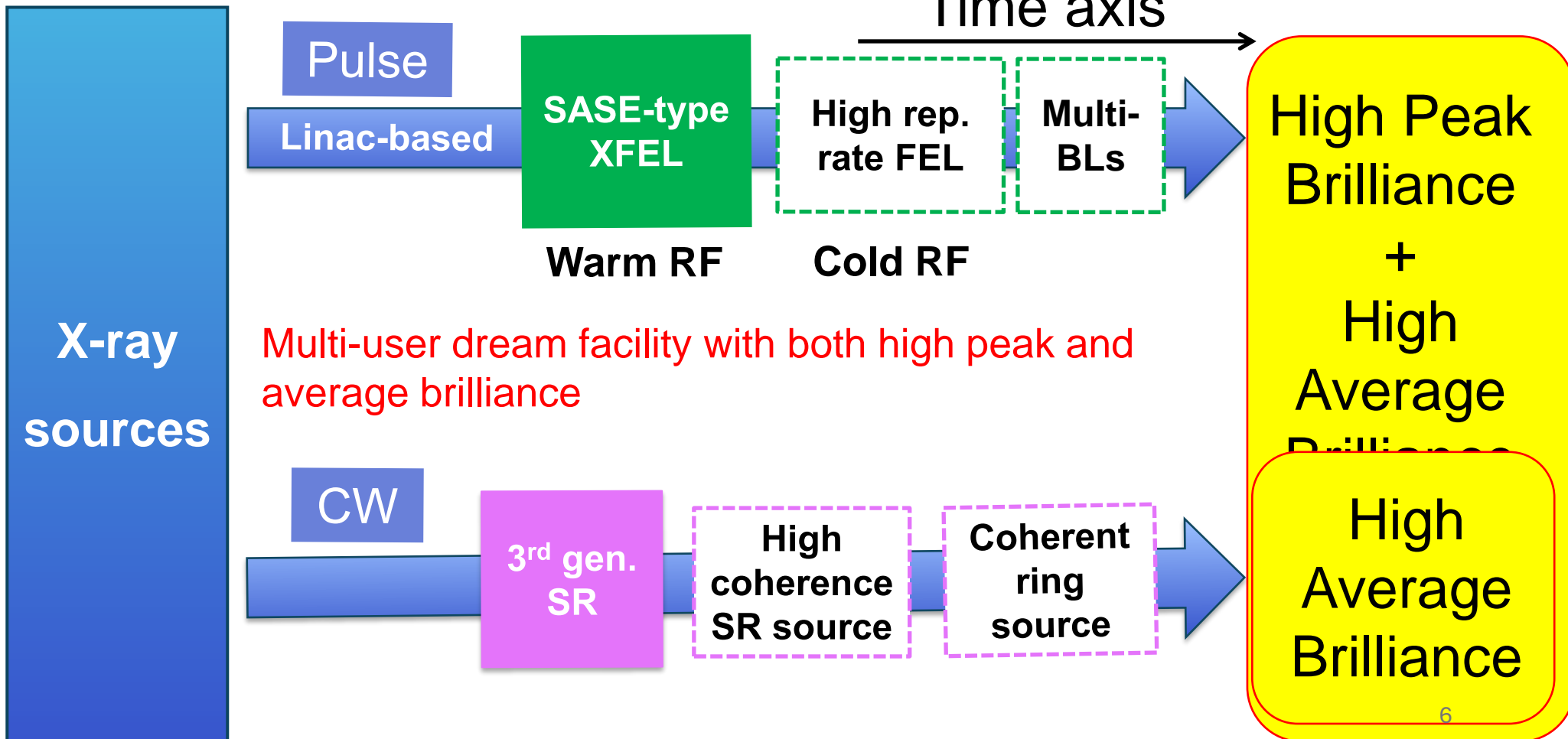

Role sharing between FELS and ring-based SRs

Performance index: Brilliance

Image of multi-user dream facility

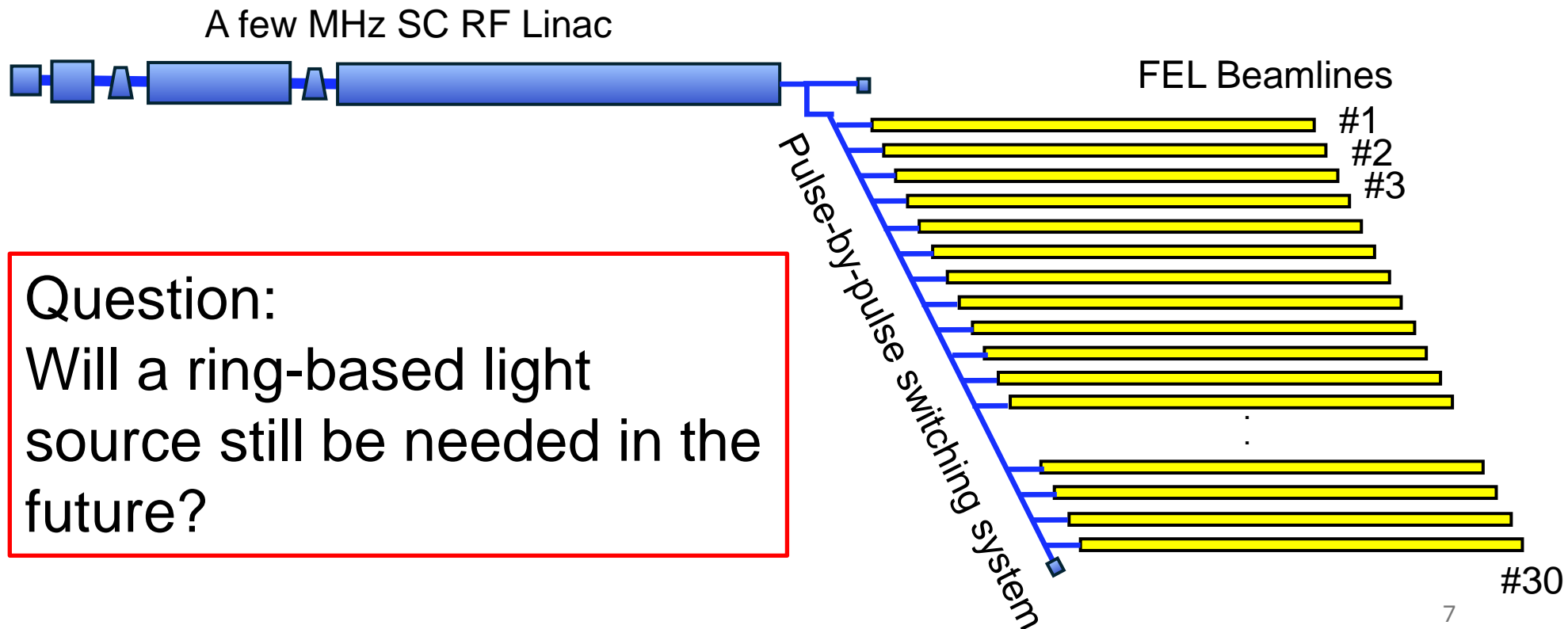

Role sharing between FELS and ring-based SRs

Performance characteristics of FELs

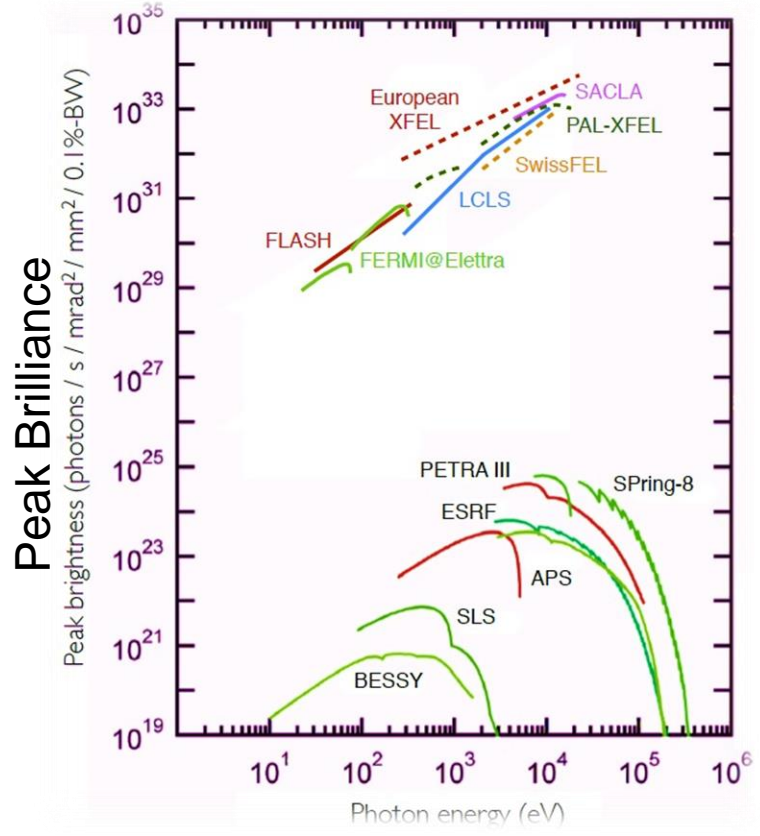

- Limited photon energy from **SX to X**
- High peak brilliance **10²⁹ to 10³⁴**
- High coherence
- Short pulse width **sub to a few tens fs**
- Non-negligible shot by shot variations

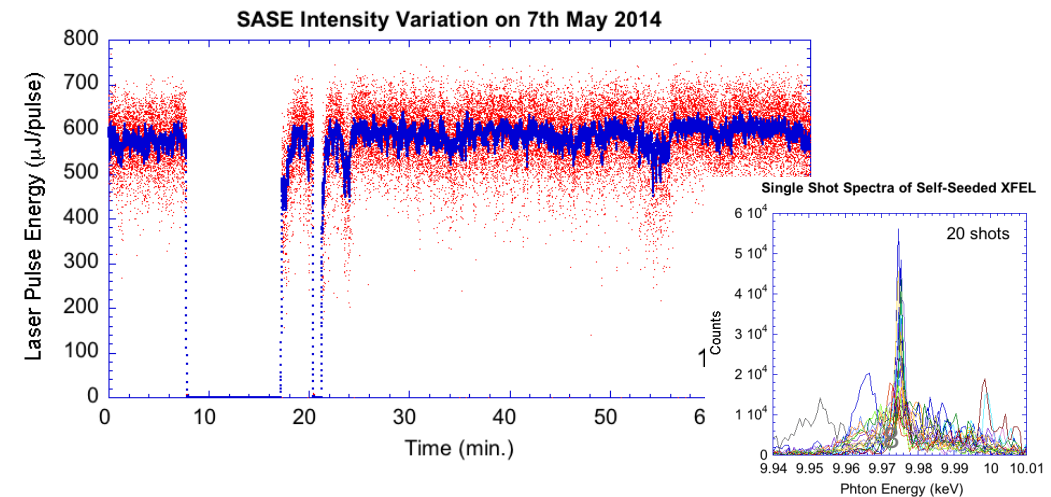

Role sharing between FELS and ring-based SRs

Performance characteristics of ring-based light source

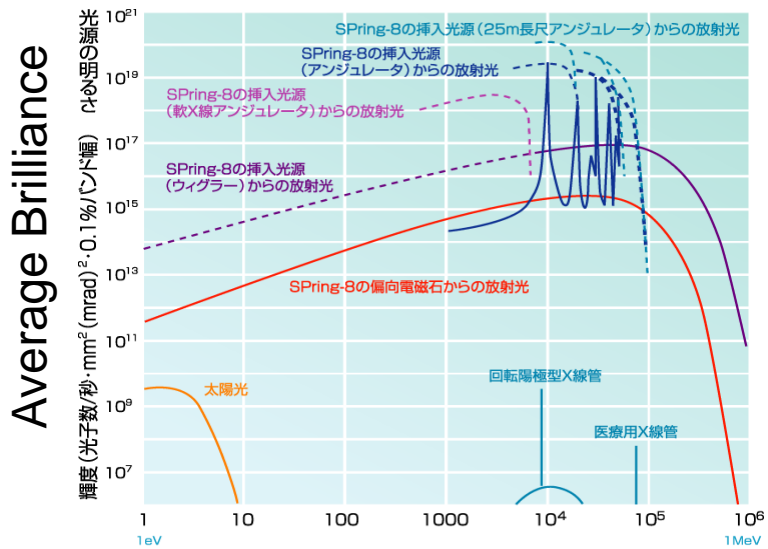

- Photon energy extended to **a few 100 keV**
- Average brilliance from **10¹⁸ to 10²¹**
- Low Coherence
- Long pulse width **a few tens ps**
- High stability and reproducibility

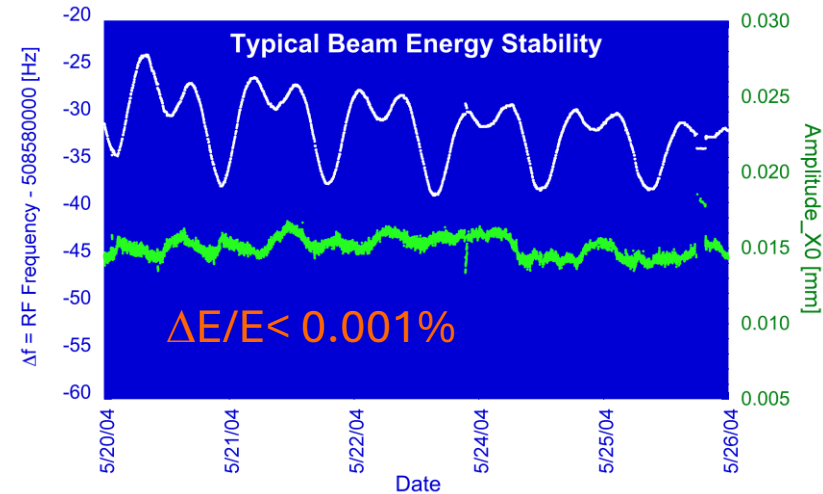
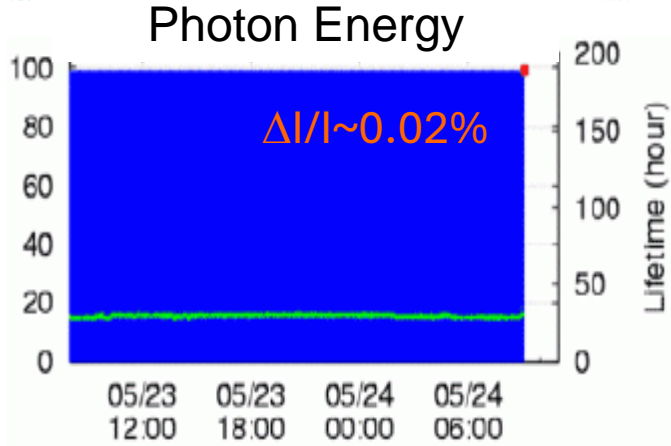

Role sharing between FELs and ring-based SRs

Systems to be studied by SRs are complex and multi-scaled in time and space

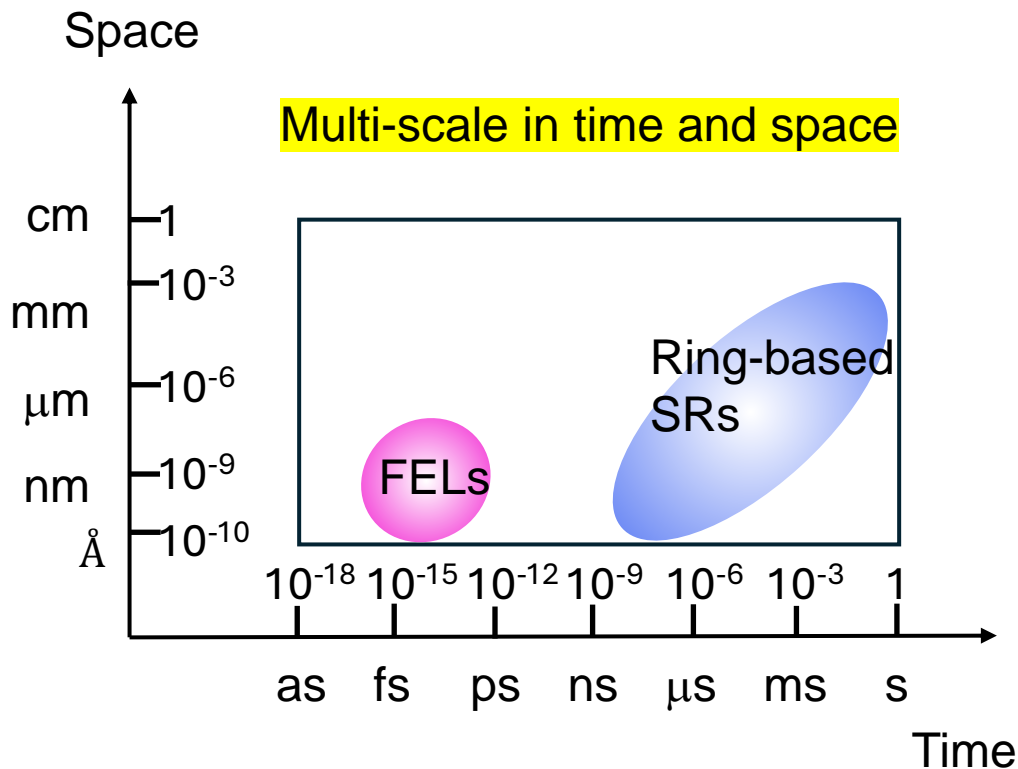

- High peak brilliance is not a universal solution
- High transverse and longitudinal coherence such as a laser is not essential for all experiments
- Correlation measurements using the same sample are extremely useful in various experiments
- The utilization of higher photon energy becomes increasingly important for various applications

1. History of synchrotron radiation source development
- 2. Diffraction-limited SR sources**
3. Single-pass free-electron lasers
4. Future development direction with a few topics

Diffraction limit

For a given wavelength λ , the product of its size and angular divergence can not be less than $\lambda/4\pi$ ($= \varepsilon_{ph}$). Assuming undulator radiation with a wavelength of λ_1 , and the following product is nearly $\lambda/4\pi$ in horizontal and vertical direction, this radiation is diffraction limited and of transverse full coherence.

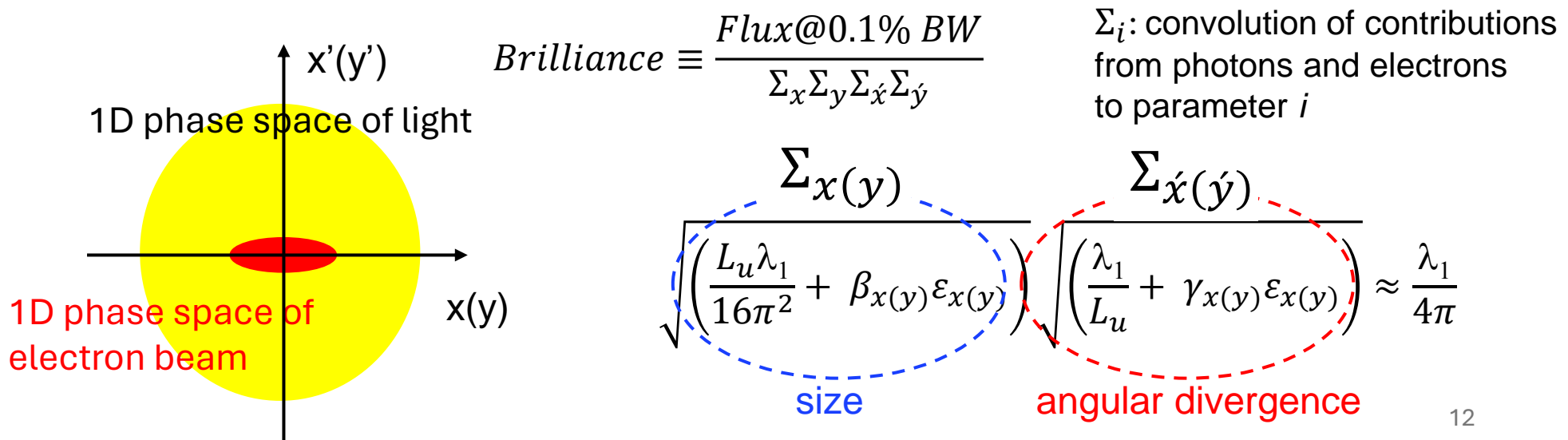

Scaling of natural emittance

$$\varepsilon = C_q \frac{\gamma^2 \left\langle \frac{H(s)}{\rho(s)^3} \right\rangle}{J_x \left\langle \frac{1}{\rho(s)^2} \right\rangle} \propto \frac{\gamma^2 \theta^3}{J_x},$$

γ : Lorentz factor

θ : Bending angle

ρ : bending radius

H: *H*-function

J_x : Damping partition number

$$H(s) = \frac{1 + \alpha_x^2(s)}{\beta_x(s)} \eta_x^2(s) + 2\alpha_x(s) \eta_x(s) \eta'_x(s) + \beta_x(s) \eta_x'^2(s),$$

η_x : Horizontal dispersion

η'_x : Horizontal dispersion angle

β_x : Horizontal beta

α_x : Horizontal alfa

As the number of bending magnets increases, natural emittance decreases inversely proportional the cubic of that number.

Suppression of radiation excitation to achieve lower emittance

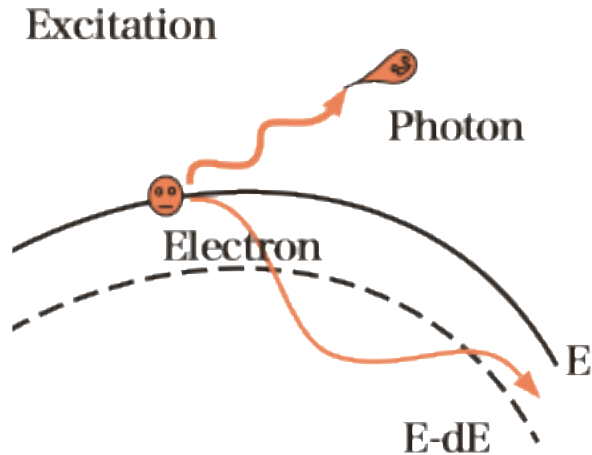

The excited amplitude of a betatron oscillation is determined by the **local energy dispersion**.

The MBA lattice can effectively suppress the energy dispersion along the ring as shown below.

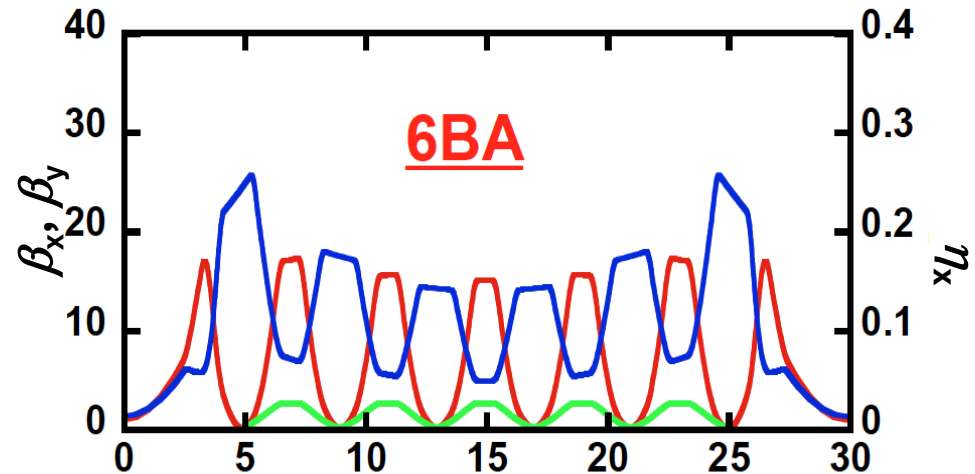
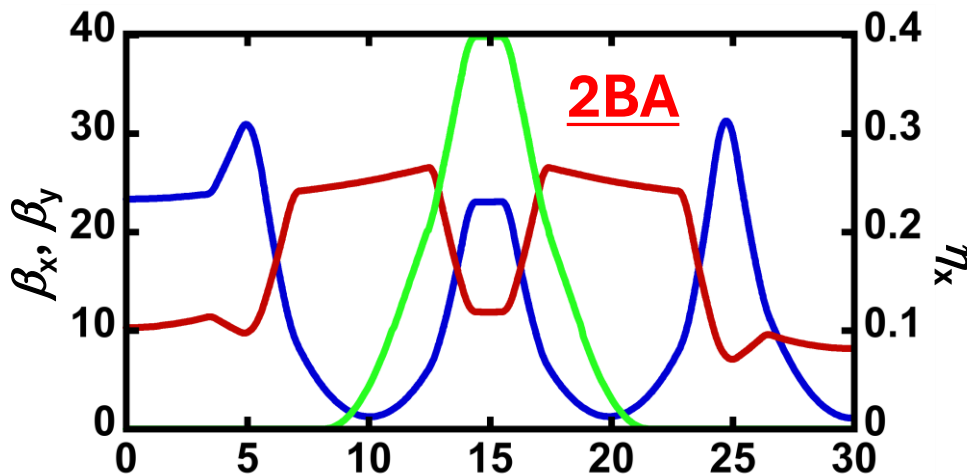

What breakthroughs made the MBA possible?

The following issues need to be overcome:

1. Narrow space issues
2. Strong nonlinearity from chromaticity correction sextupoles
3. Beam injection scheme applicable for a ring with a small dynamic aperture
4. Stable top-up beam injection compensating a short beam-lifetime and transparent against small emittance stored beam

What breakthroughs made the MBA possible?

1. Solving narrow spacing issues

Q1: The MBA lattice naturally requires the large number of focusing quadrupoles to focus the beam at each BM horizontally.
How can numerous magnets be accommodated within a limited space?

Q2: The shorter focal length and smaller energy dispersion increase the strength of both quadrupole and sextupole magnets.
How can extremely strong quadrupole and sextupole fields be achieved?

What breakthroughs made the MBA possible?

A1/A2: Adoption of the compact vacuum chamber w/wo NEG coating

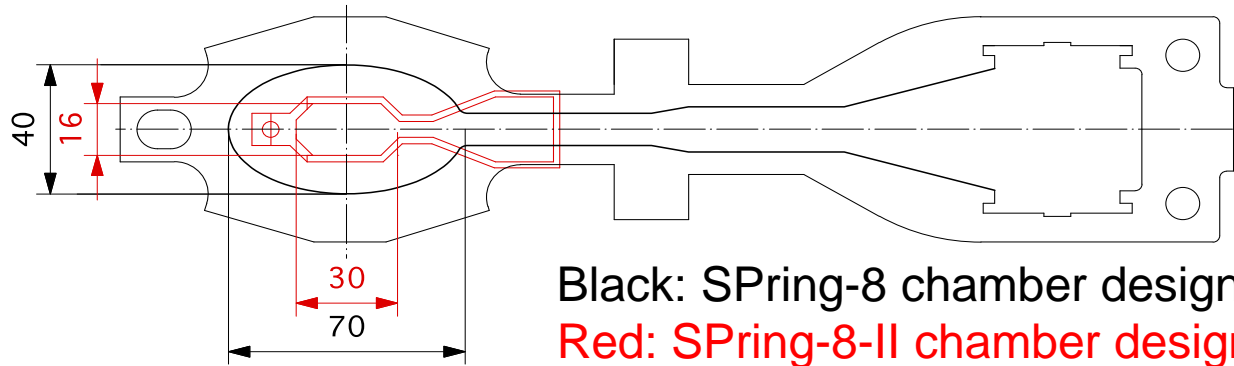

Black: SPring-8 chamber designed 35 years ago
 Red: SPring-8-II chamber designed recently

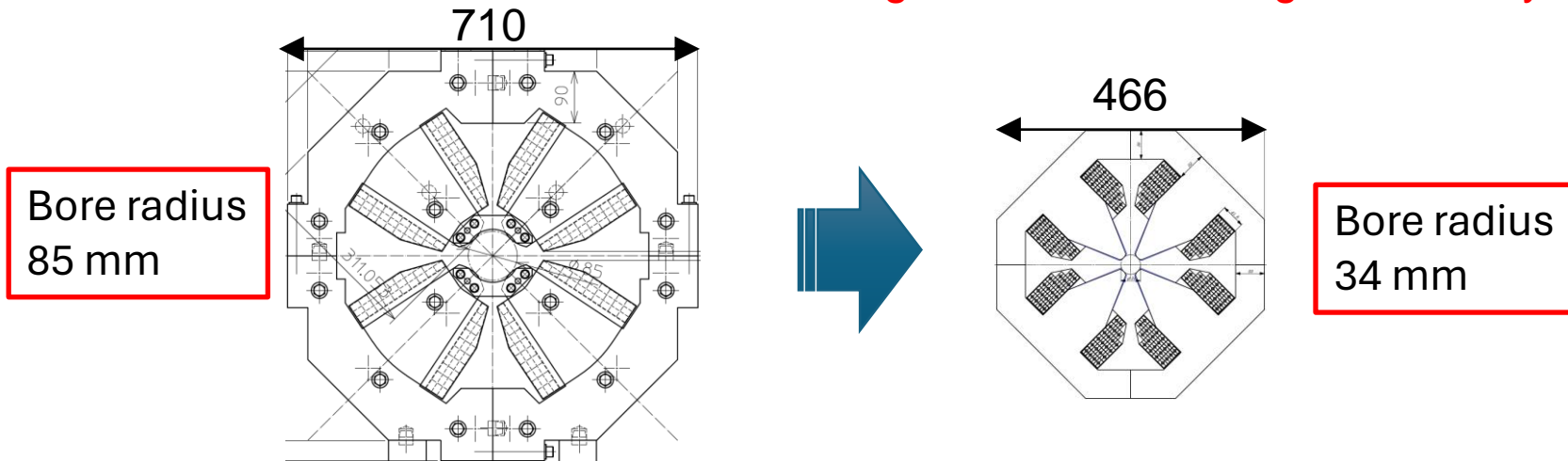

Bore radius
85 mm

Bore radius
34 mm

What breakthroughs made the MBA possible?

A1/A2: Adoption of a single-yoke composite magnet with a spaghetti-type chamber

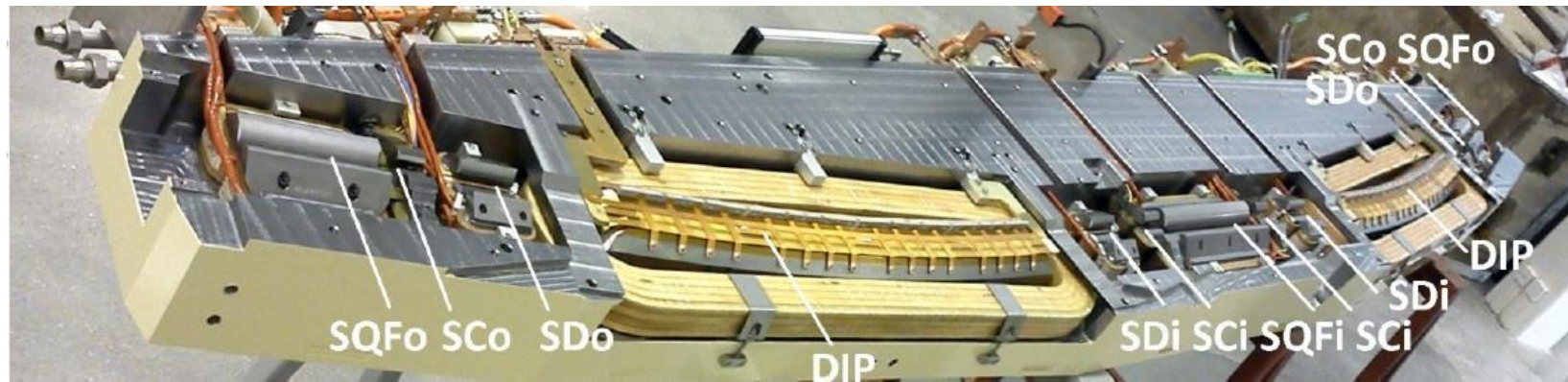

M. Johansson et. al., *Proc. of NAPAC2016*, Chicago, IL, USA (2016) pp. 1058-1066

1. History of synchrotron radiation source development
2. Diffraction-limited SR sources
- 3. Single-pass free-electron lasers**
4. Future development direction with a few topics

Brief history

The development of a single-pass FEL originated from the TTF (TESRA Test Facility), the test-bed for ILC at DESY and 1.3 GHz superconducting RF system was developed. In **2000**, First SASE (Self-Amplified Spontaneous Emission) lasing was observed at 109 nm [1]. TTF demonstrated the SESE scheme operating in the short-wavelength region, thereby establishing the foundation for X-ray FELs subsequently constructed worldwide.

In **2009**, LCLS (Linac Coherent Light Source) at SLAC achieved first SASE lasing at 0.12 nm using normal conducting S-band linac (a part of Stanford two-mile linac), out-of-vacuum undulator, RF gun system and so on.

Era of single-pass FEL in short wavelengths was open-up.

[1] J. Andruszkow et. al., *PRL* **85**(18) (2000) 3825-3829

[2] P. Emma et. al., *Nat. Photon.* **4** (2010) 641-547

Self-Amplified Spontaneous Emission

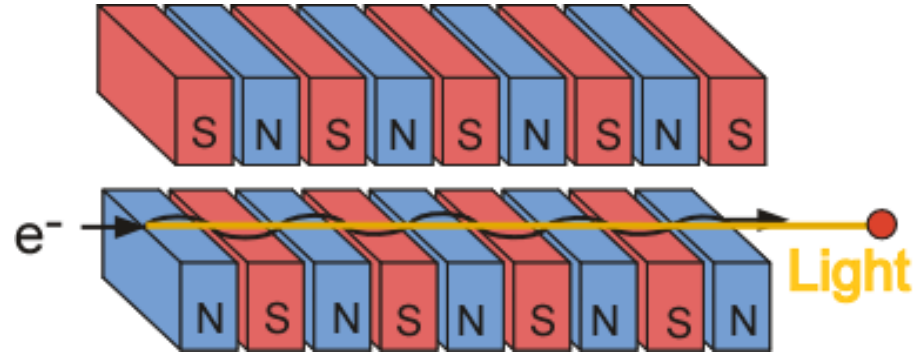

Resonant wavelength of undulator

$$\lambda = \frac{\lambda_u}{2\gamma^2} \left(1 + \frac{K^2}{2} \right)$$

$$K = \frac{eB_u\lambda_u}{2\pi m_e c}$$

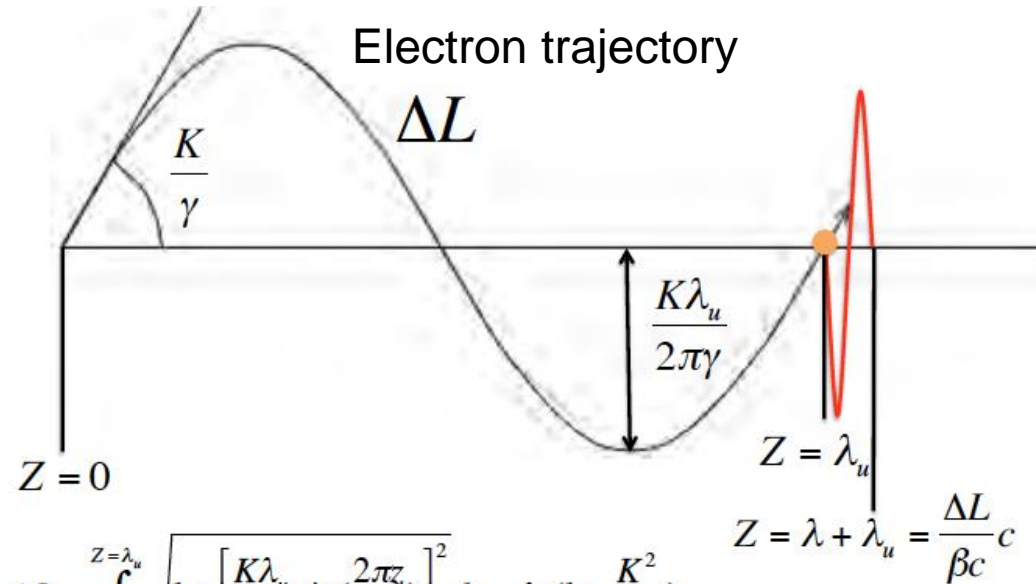

$$\Delta L = \int_{Z=0}^{Z=\lambda_u} \sqrt{1 + \left[\frac{K\lambda_u}{2\pi\gamma} \sin\left(\frac{2\pi z}{\lambda_u}\right) \right]^2} dz \approx \lambda_u \left(1 + \frac{K^2}{4\gamma^2} \right)$$

Self-Amplified Spontaneous Emission

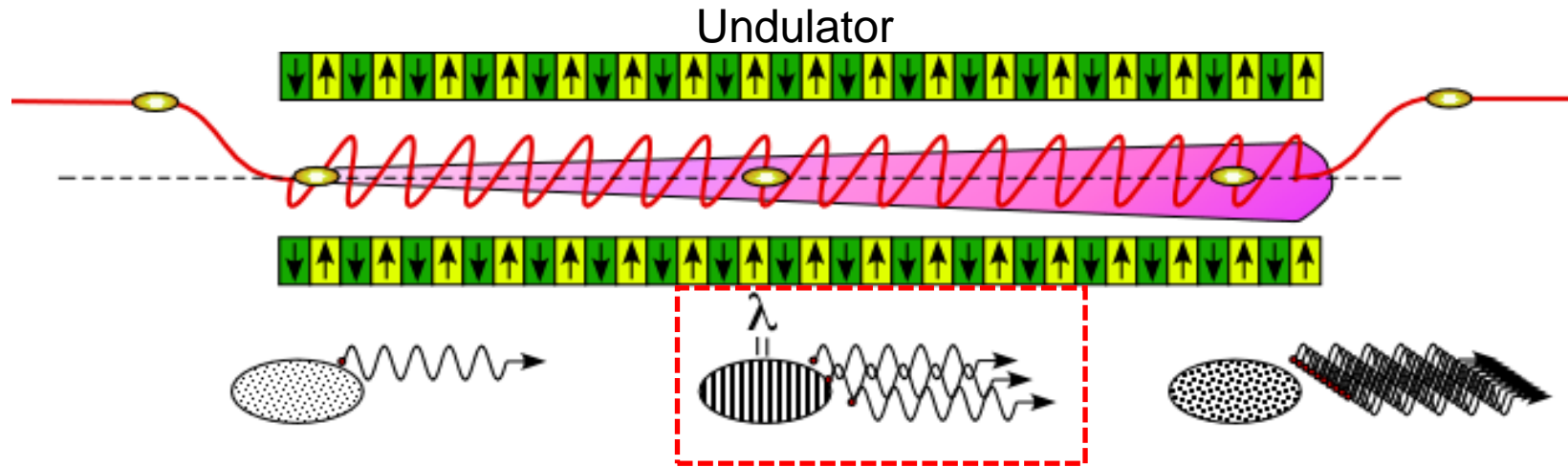

Light overtakes electrons by one wavelength for every one undulation period

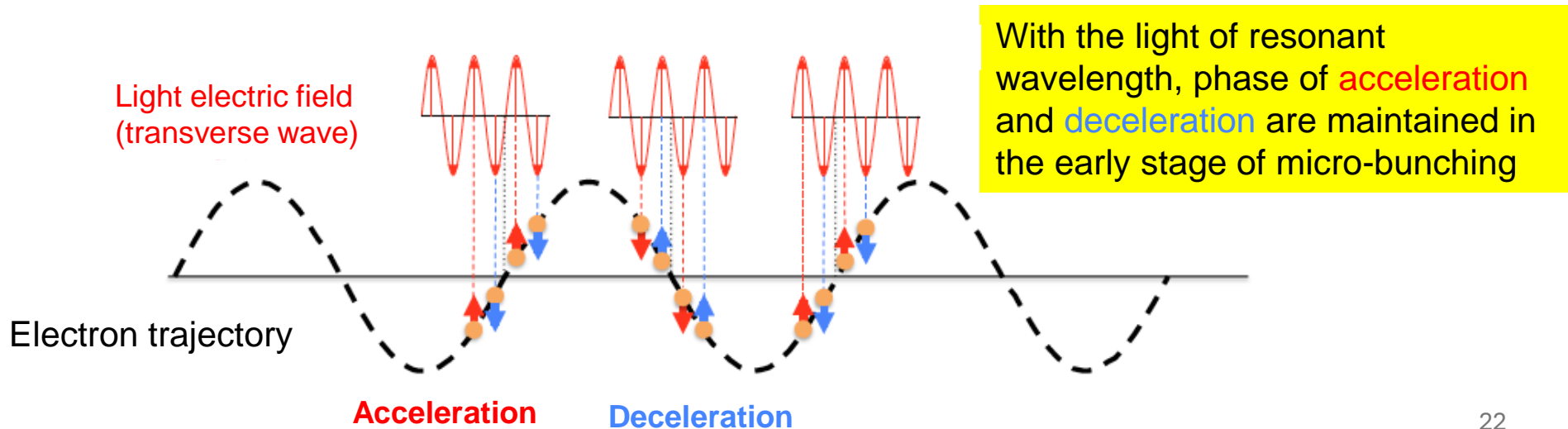

Self-Amplified Spontaneous Emission

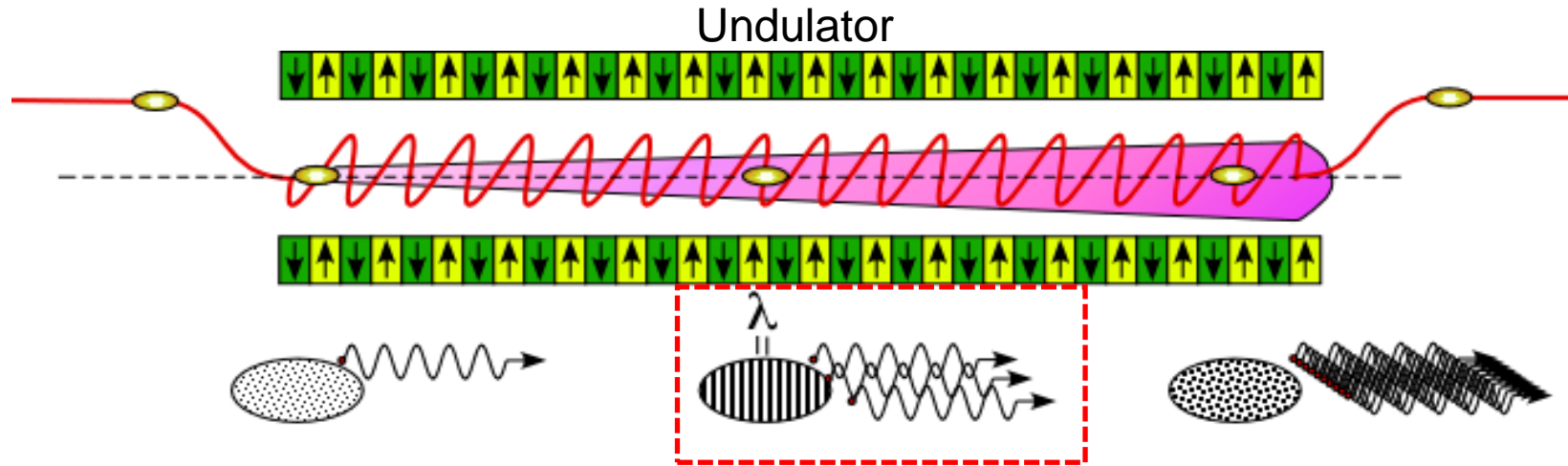

Electrons gaining and losing energy gather towards at the field zero crossing points

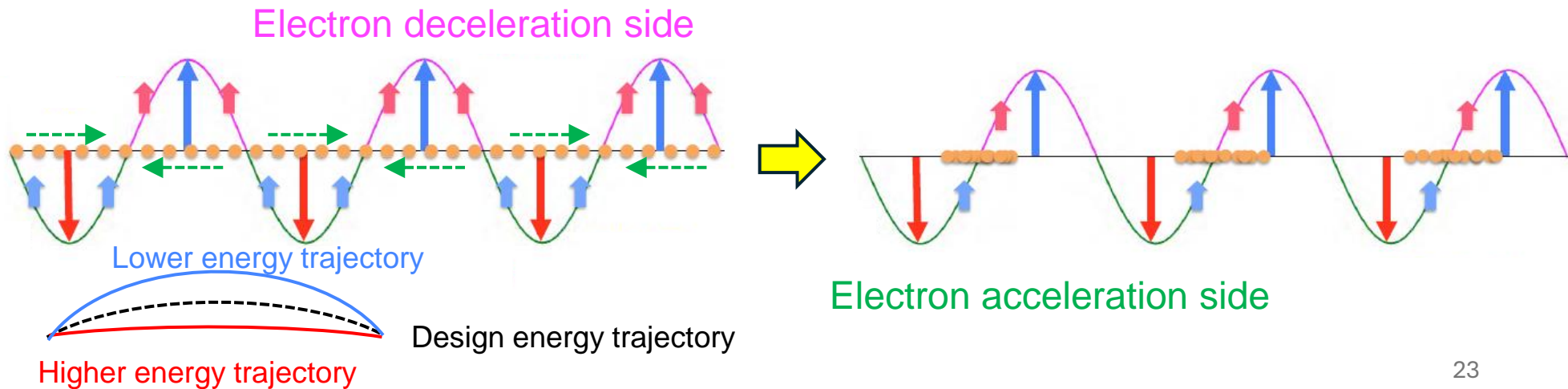

Self-Amplified Spontaneous Emission

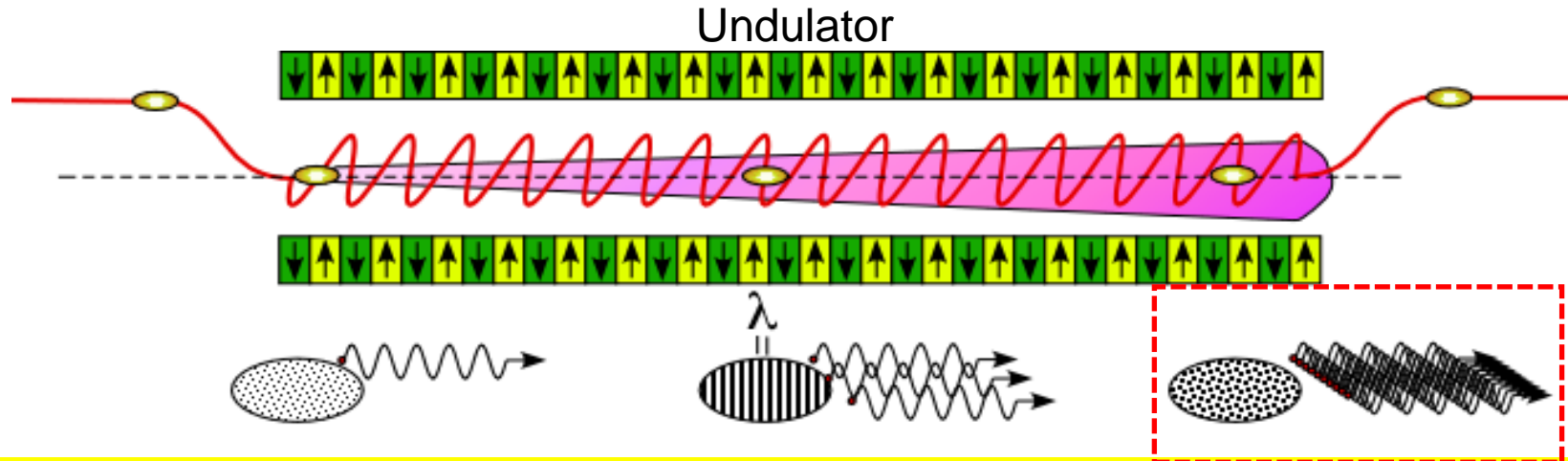

Energy exchange with electrons modulates the phase of light electric field

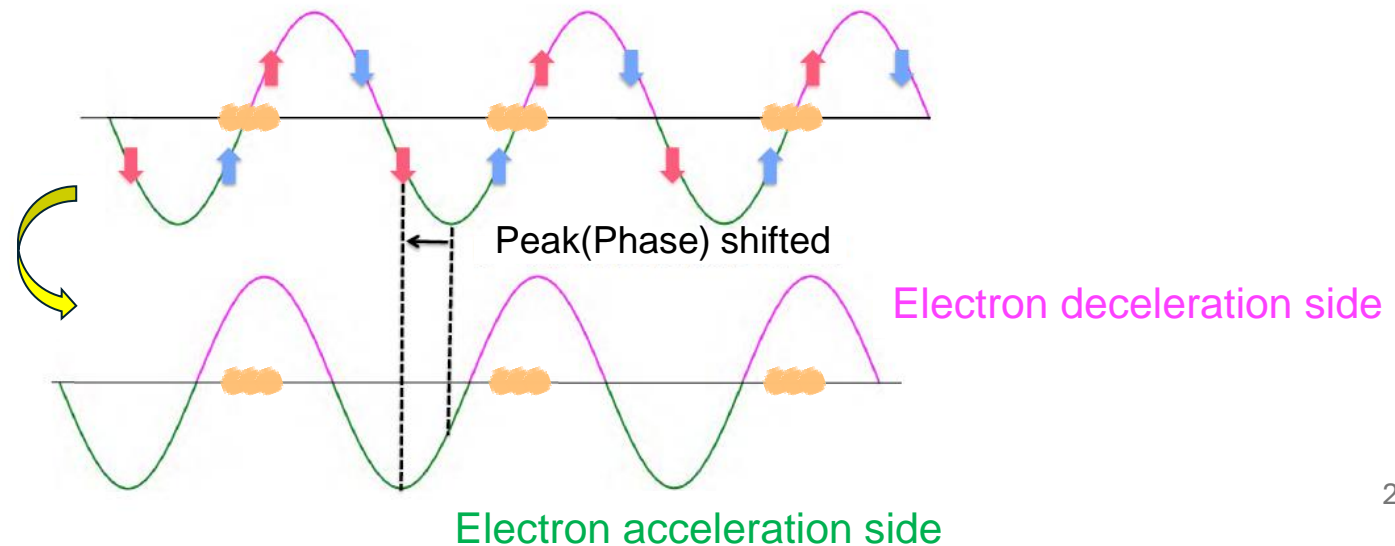

Self-Amplified Spontaneous Emission

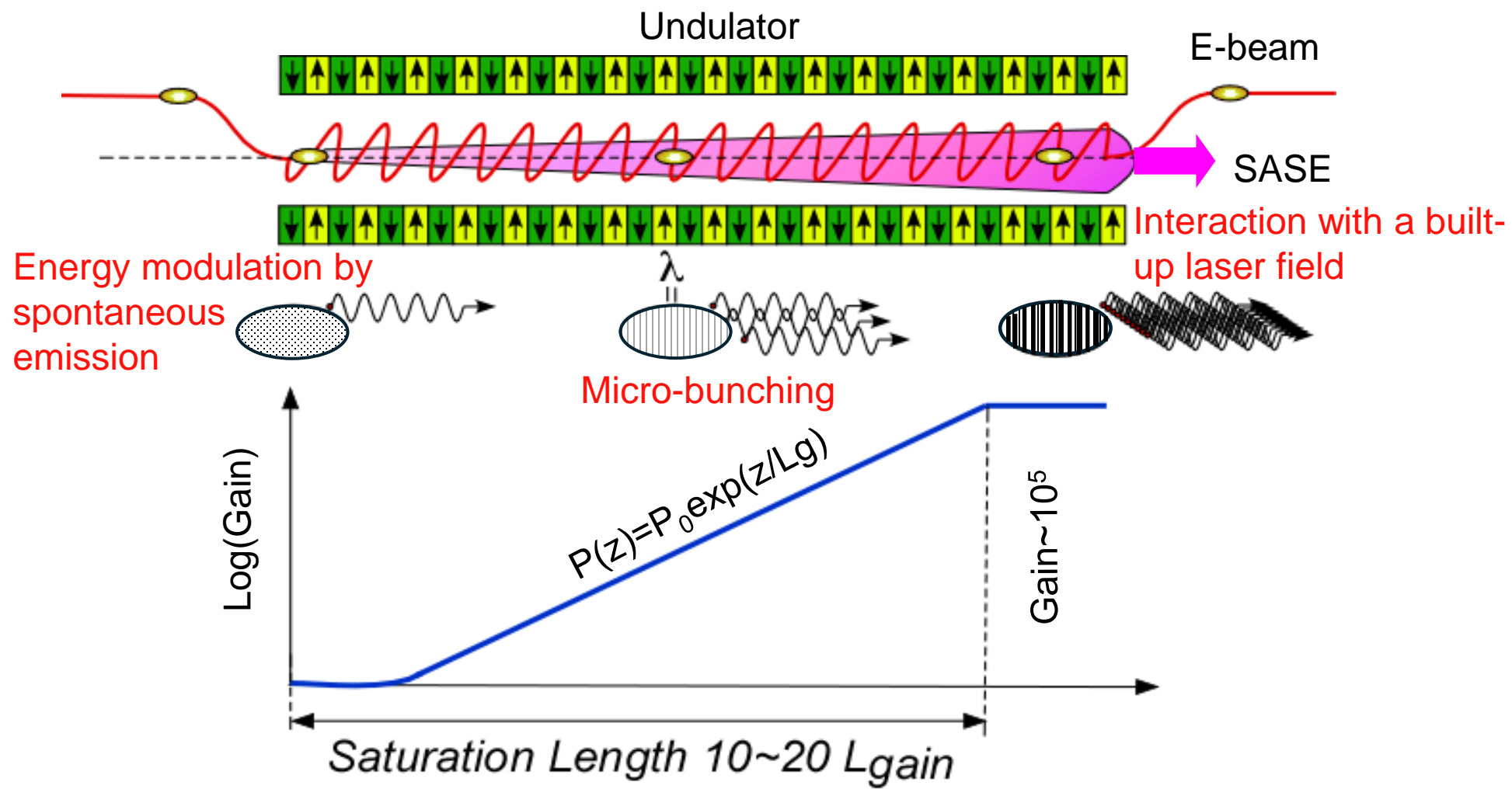

1D SASE gain length

The gain length L_G represents the undulator length enhancing the laser power by a factor of e (approximately 2.7).

$$P(z) \propto \text{Exp} \left(\frac{z}{L_G} \right),$$

$$L_G = \frac{\lambda_u}{4\pi\sqrt{3}\rho},$$

$$L_G \propto \rho^{-1} \propto \left(\frac{\sigma_x \sigma_y}{I_p} \right)^{1/3} \approx \left(\frac{\langle \beta \rangle \epsilon_s}{I_p} \right)^{1/3}$$

Averaged beta over the undulator

Emittance at the lasing slice

Peak current at the lasing slice

Single-pass FEL system

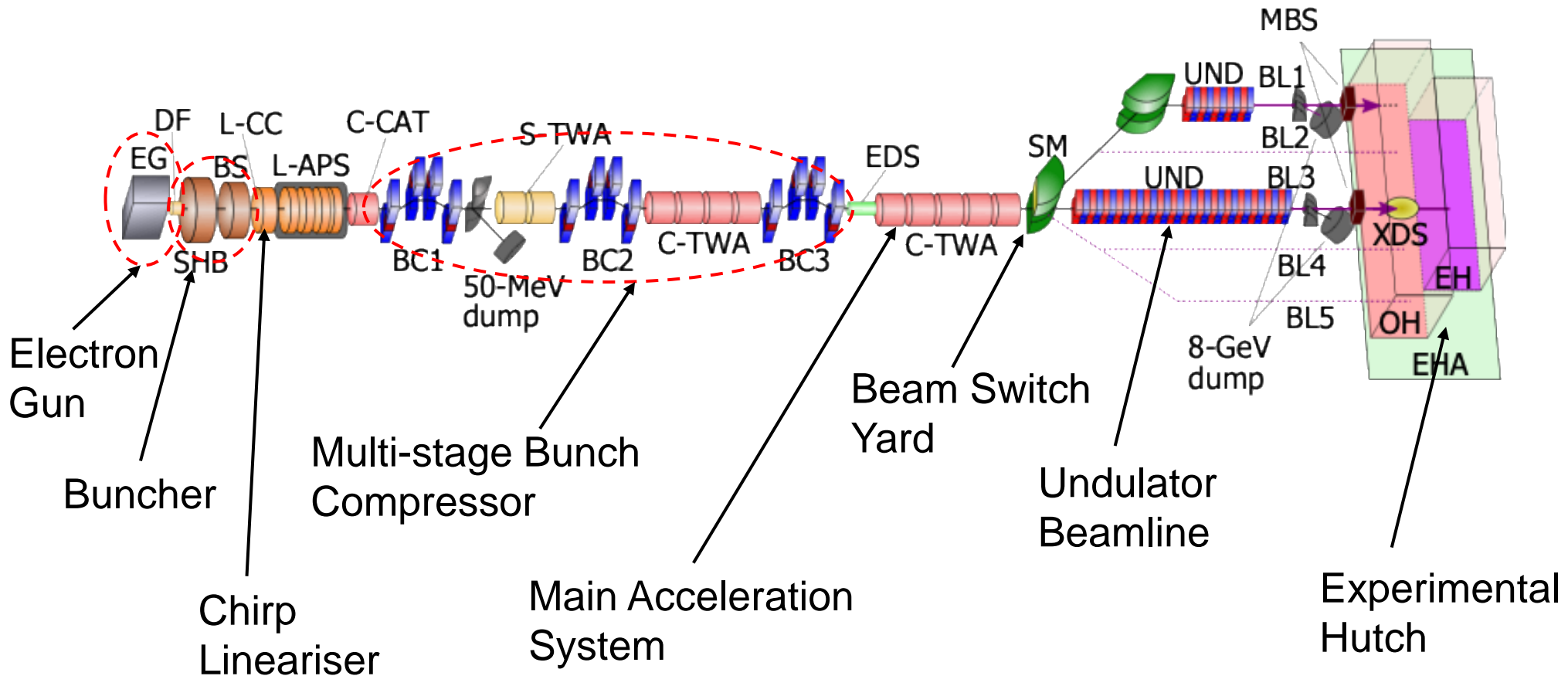

T. Ishikawa et. al., *Nat. Photon.* **6** (2012) 540-544

High repetition rate XFEL based on superconducting linac (mainstream)

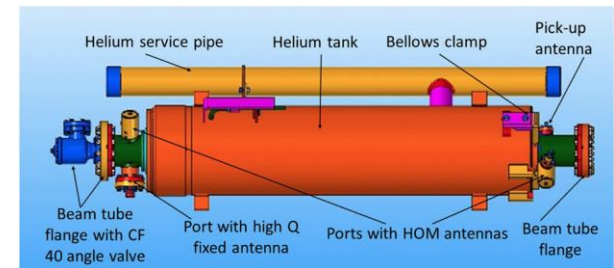
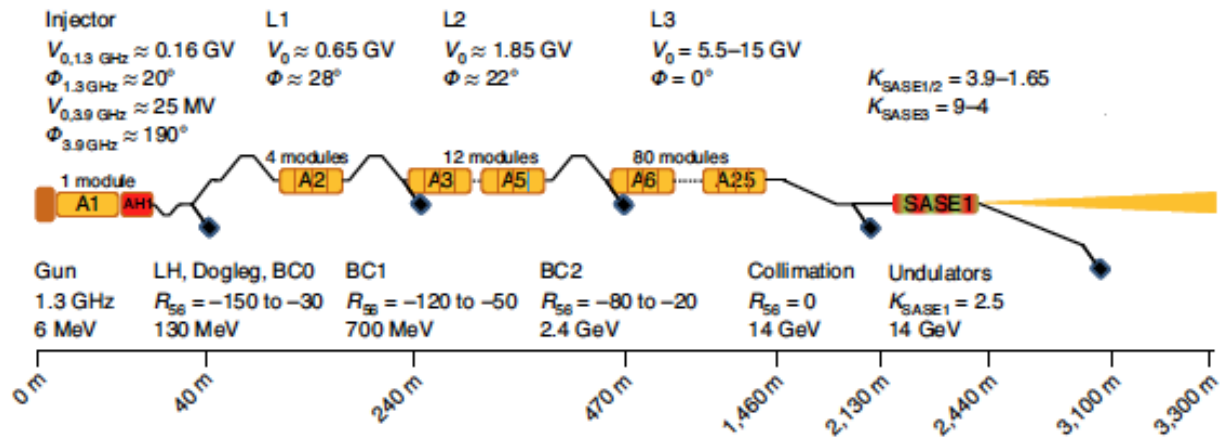

(a)

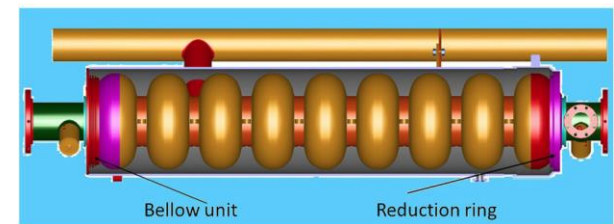

(b)



W. Decking et. al., *Nat. Photon.* **14** (2020) 391-397

SPring-8 Compact SASE Source (SCSS)

Lower Beam Energy ←



Size Reduction



Efficient Acceleration ←



Further Size Reduction

Smaller Normalized
Beam Emittance ←

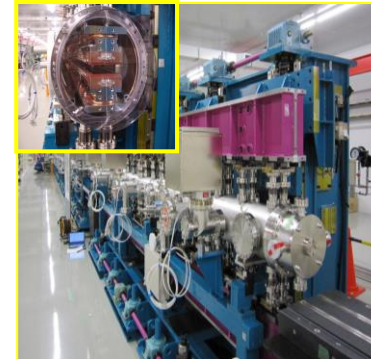

Short period
in-vacuum
undulator



C-band high
gradient
acceleration
system



Thermionic
gun based
low emittance
injector

Variety of XFELs

1. Two-color FEL
2. Self-seeded FEL
3. Circular-/linear-polarized FEL
4. **Extremely short-pulsed FEL**

Two-color XFEL with wide tunability

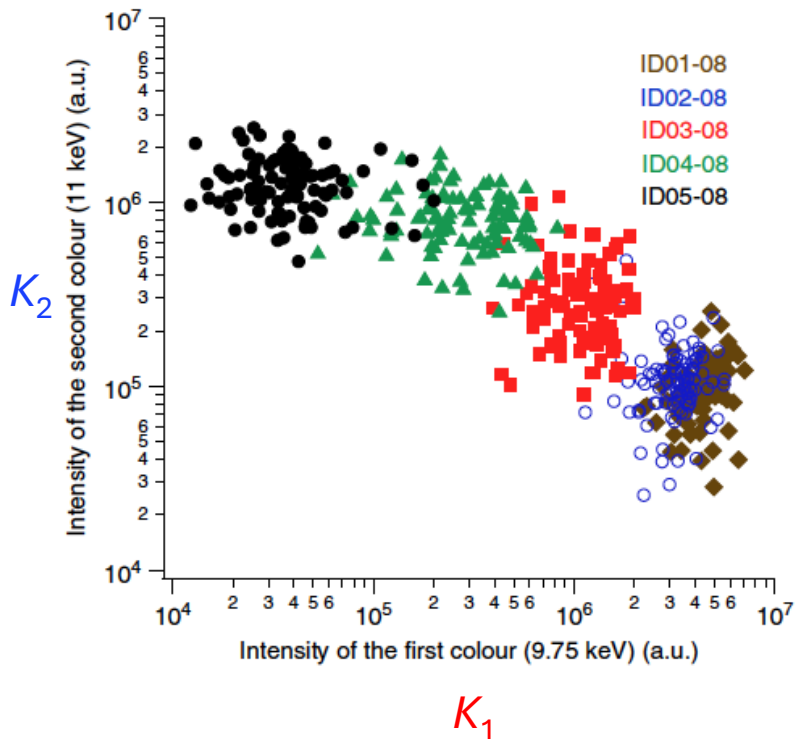
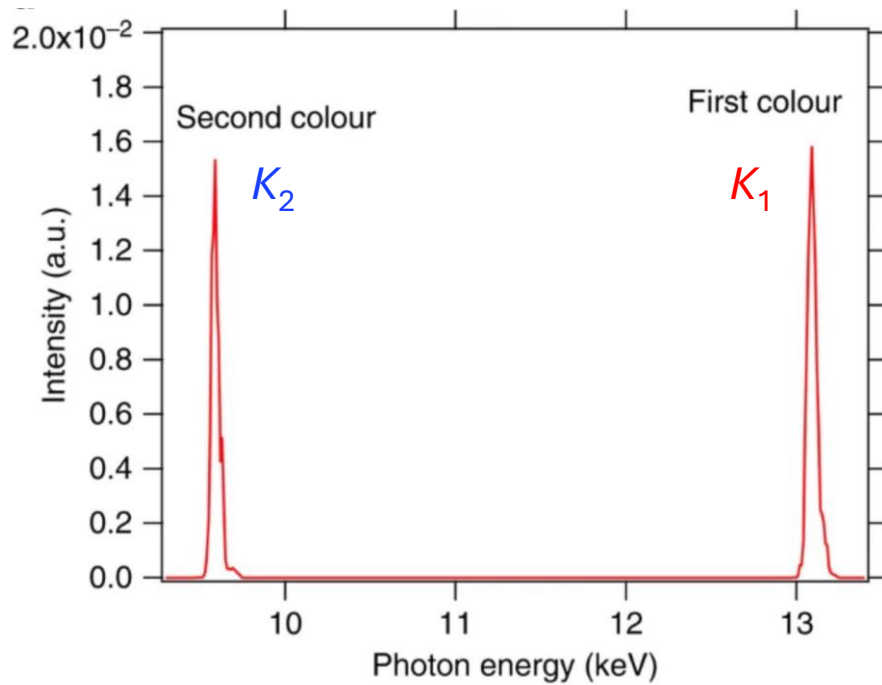
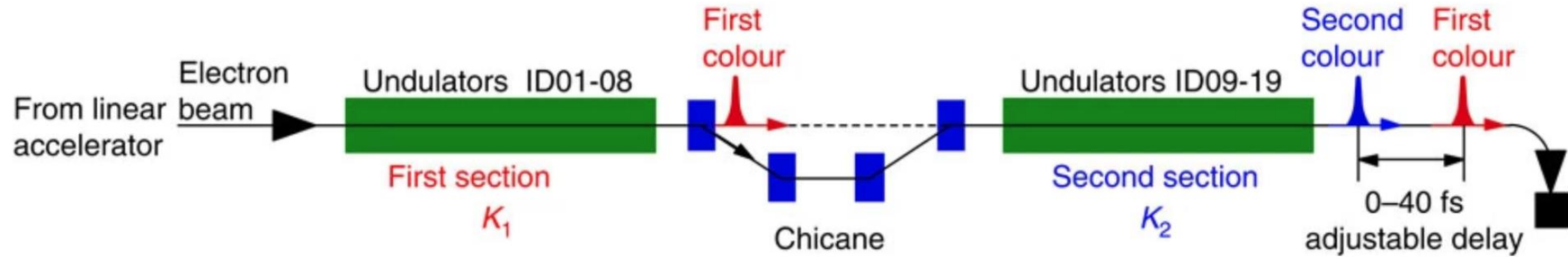

Self-seeding with reflective geometry

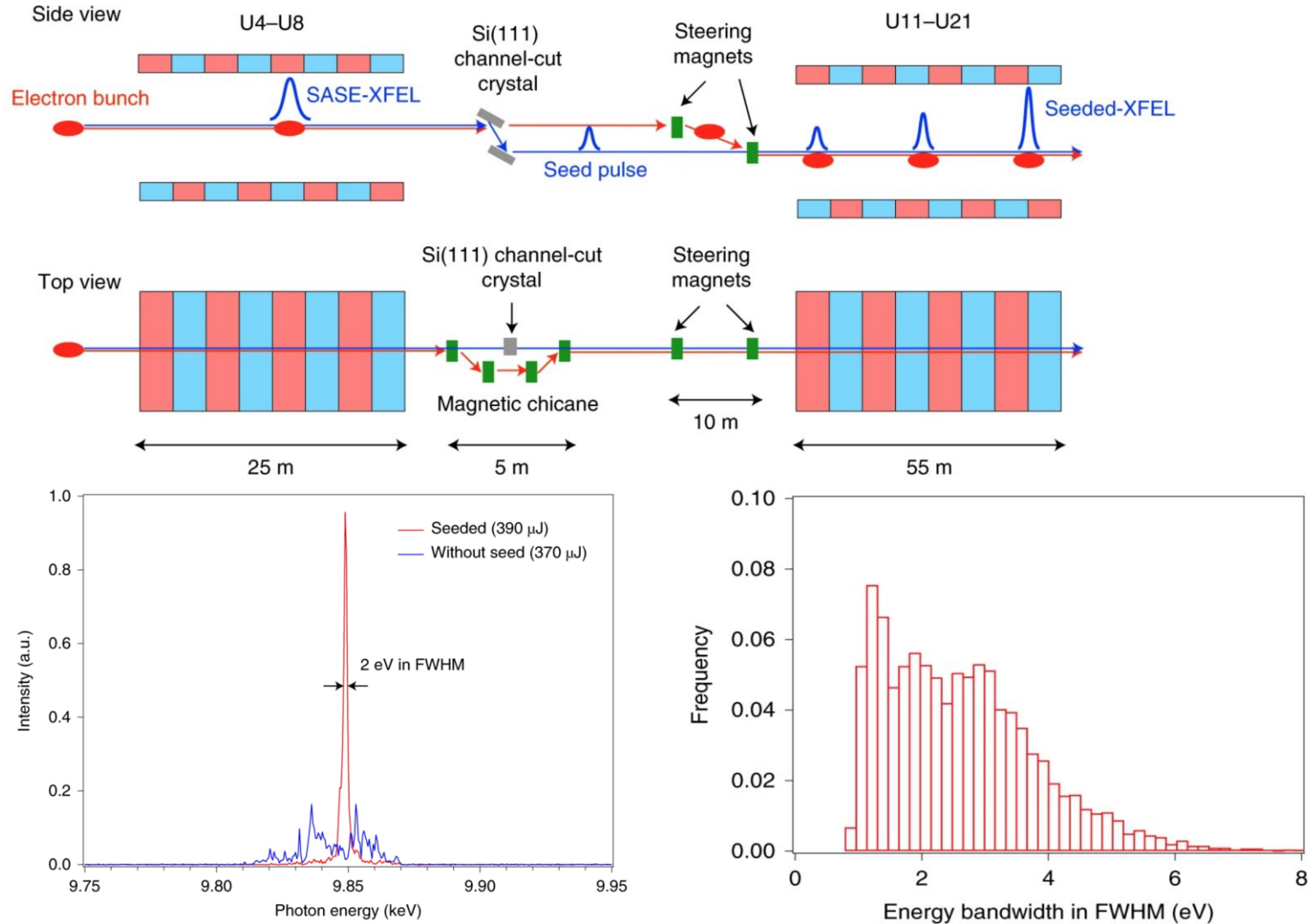

Circular-polarization XFEL

XPR(X-ray phase retarder)

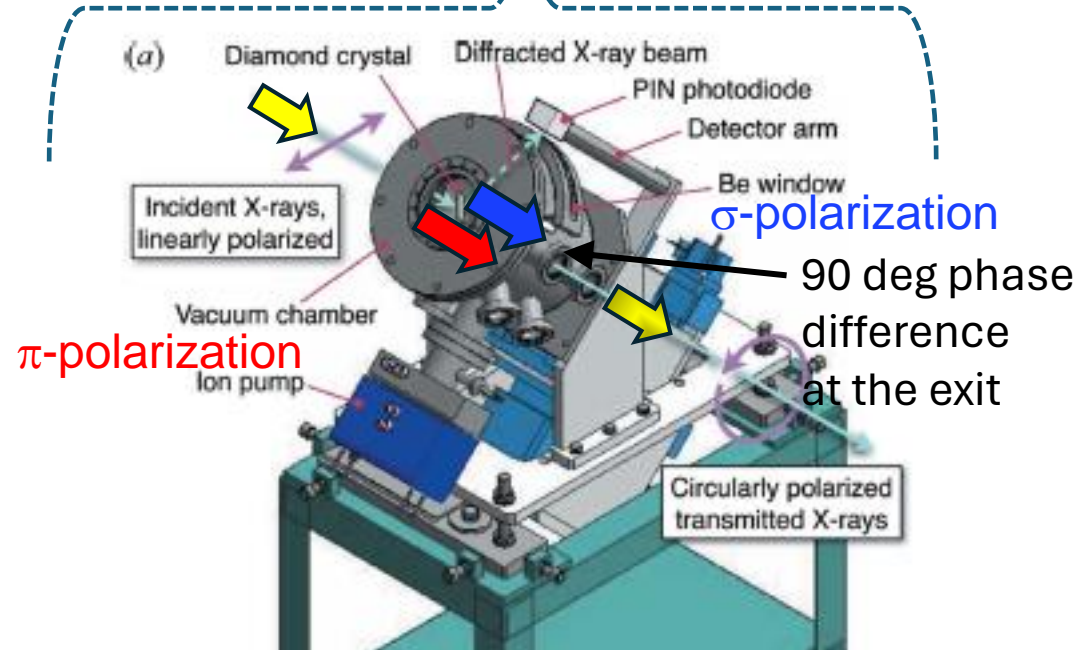
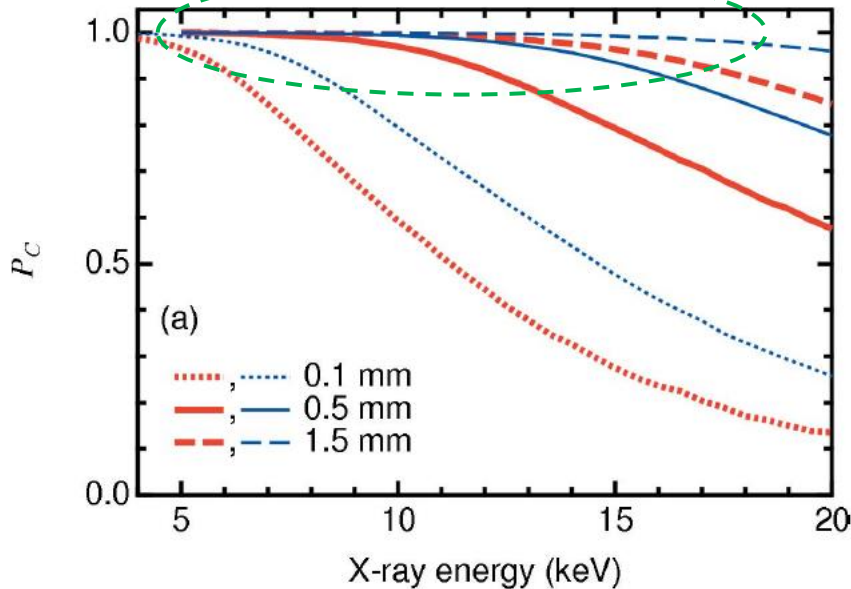
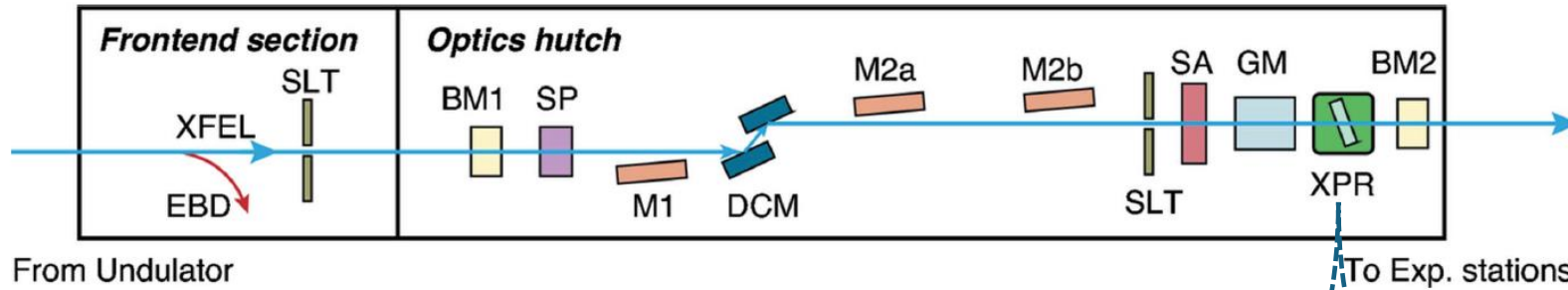

1. History of synchrotron radiation source development
2. Diffraction-limited SR sources
3. Single-pass free-electron lasers
4. Future development direction with a few topics

Post diffraction limited SR

- Longitudinally coherent x-ray generation-

The diffraction limited condition means the X-ray brilliance by undulator radiation is no longer enhanced even when natural emittance is reduced.

To dramatically increase the brilliance, **paradigm-shift** from “spontaneous radiation” to “longitudinally coherent radiation” is required.

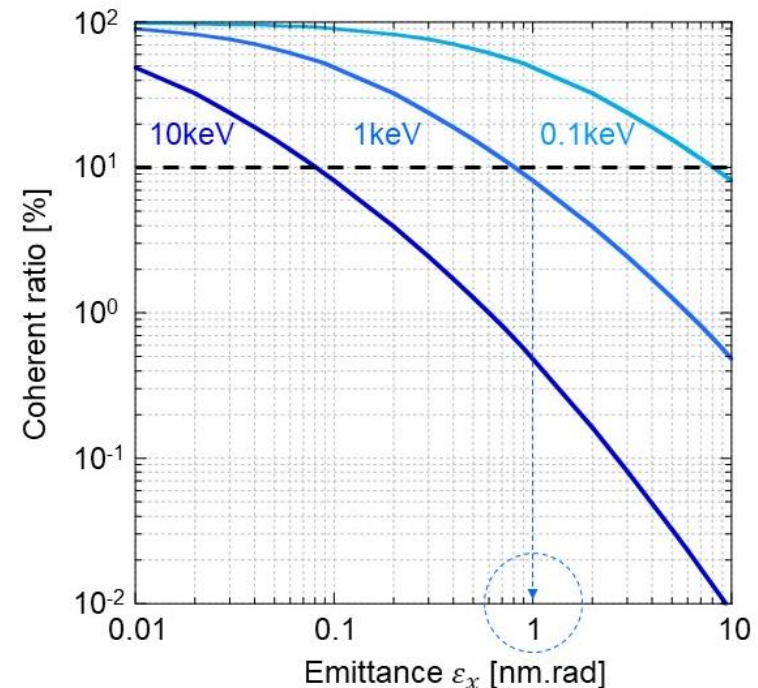

Cavity-based FEL in a diffraction-limited SR

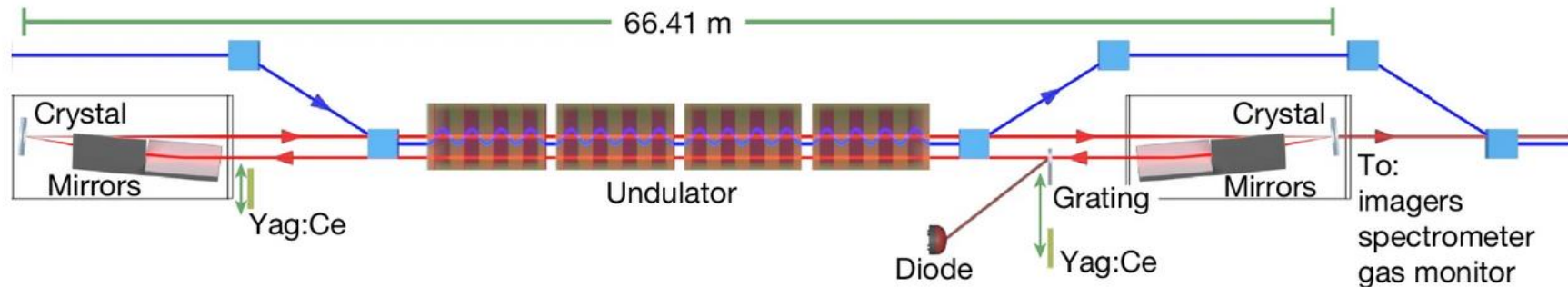

The first proof-of principle Experiment was performed at the SASE1 undulator line of the European XFEL. The X-ray cavity consists of two diamond crystals in Bragg reflection working close to backscattering geometry. The elements in the retro-reflector are aligned such that the beam after reflection returns at a distance of 2.67 mm from the incident beam inside the same vacuum pipe. The downstream retro-reflector unit (on the right) is adjustable to tune the cavity length. The electron beam (blue) is injected from the left using a magnetic chicane, and the X-ray pulse (red) is circulating in the cavity, overlapping with electron bunches that pass the undulator at 2.23 MHz.

Towards brilliant atto-second X-ray generation

A frontier of practical “single” atto-second brilliant X-rays remains.

- 1) Tuesday 19th afternoon: “Attsecond FEL Physics” by Agostino Marinelli (SLAC)
- 2) Thursday 21st, morning: “Generation of tunable sub-femtosecond XFEL pulses by electron bunch recompression using reverse-energy chirp” by Kenji Yasutome (RIKEN)

Towards brilliant atto-second X-ray generation

A frontier of practical “single” atto-second brilliant X-rays remains.

1) ESASE(Enhanced SASE) scheme

A. Zholents and W. Fawley, *PRL* 92, 224801 (2004); A. Zholents and G. Penn, *PRAB* 8, 050704 (2005); A. Zholents, *PRAB* 8, 040701 (2005); E. Saladi et. al., *PRAB* 9,050702 (2006); Y. Ding et. al., *PRAB* 12, 060703 (2009); J. Duris et. al., *Nat Photon* 14, 30-36 (2020)

2) Slotted foil scheme

P. Emma et. al., *PRL* 92, 074801 (2004); A. Marinelli et. al., *APL* 111, 151101 (2017)

3) ESASE seeding scheme T. Tanaka, *PRL* 110, 084801 (2013)

4) Hard bunch compression scheme

S. Huang et. al., *PRL* 119, 154801 (2017); E. Prat et. al., *APL Photonics* 8, 111302 (2023); E. Prat et. al., *PRRes* 7, L042060 (2025)

5) Scheme using a reverse-chirp due to a space charge force

J. Yan et. al., *Nat Photon* 18, 1293-1298 (2024)

6) Scheme using slippage over the undulator T. Tanaka, *PRL* 114, 044801 (2015)

ESASE(Enhanced SASE) scheme

$\lambda_L = 800 \text{ nm}$, $P_L = \sim 6 \text{ GW}$, $\tau_L = \sim 5 \text{ fs}$

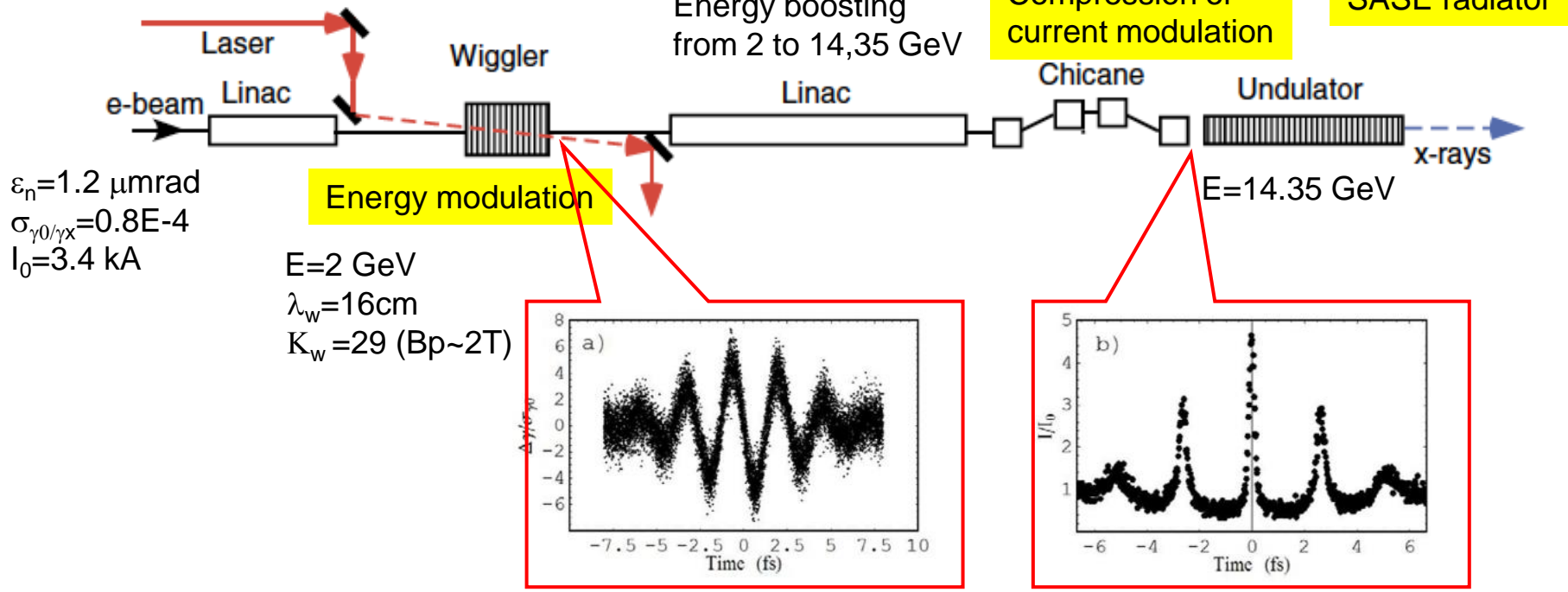

$\epsilon_n = 1.2 \text{ } \mu\text{mrad}$
 $\sigma_{\gamma 0/\gamma x} = 0.8 \text{ E-}4$
 $I_0 = 3.4 \text{ kA}$

- Energy modulation by a high-power short-pulsed laser at the wiggler section
- Converting the energy modulation to the density modulation at the chicane with help of R56(bunch compression)
- Extracting a sub-femtosecond XFEL pulse from the largest current spike

A. Zholents, *PRAB* 8, 040701 (2005).

Slotted foil scheme

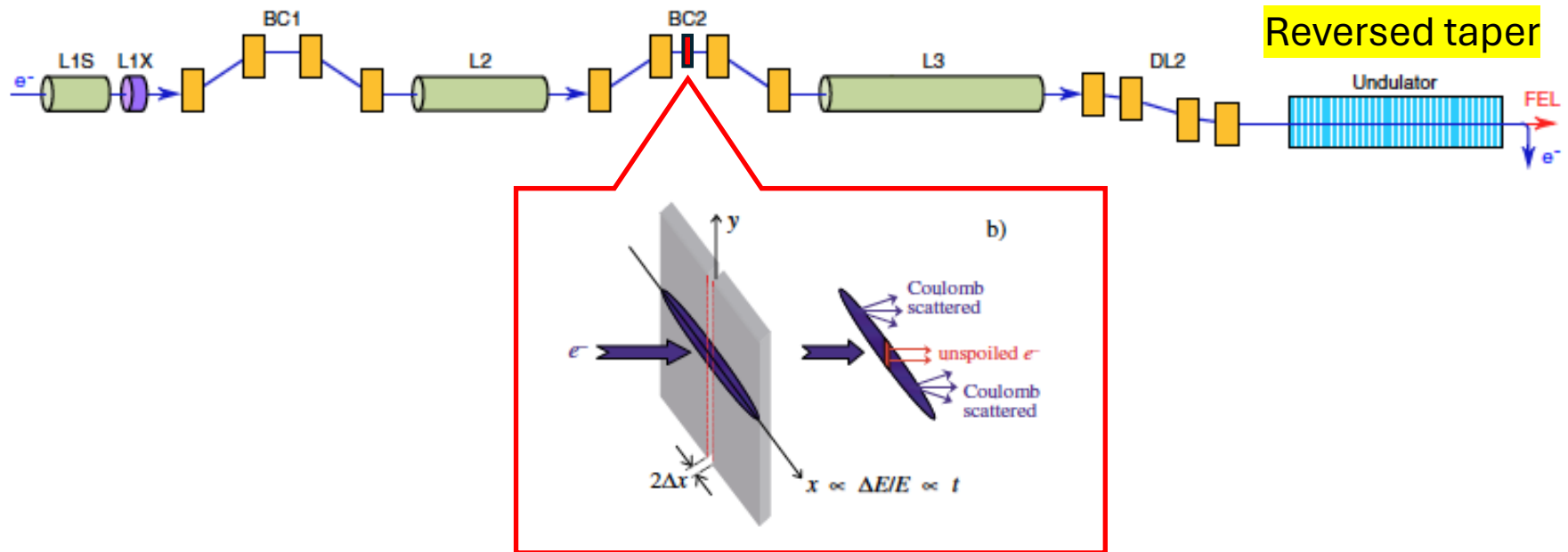

- Simple scheme
- Control the lasing beam slice into a short pulse duration
- Low electron charge -> **difficult to access high peak power**

ESASE seeding scheme

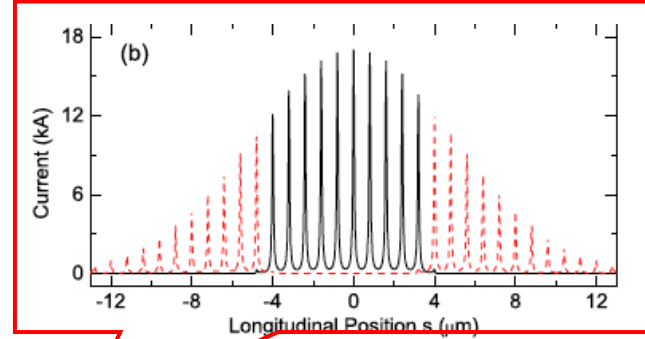
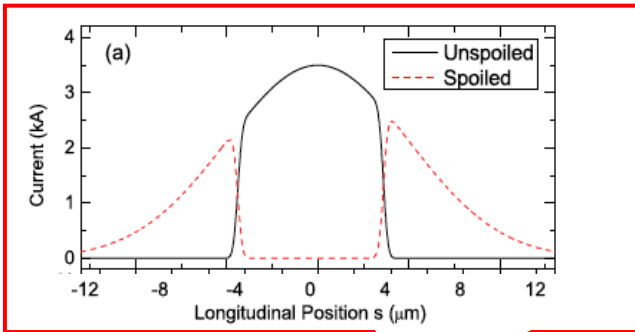

$E=8 \text{ GeV}$
 $\epsilon_n=0.7 \text{ } \mu\text{mrad}$
 $\sigma_{\gamma 0/\gamma x}=1 \text{ E-4}$
 $I_0=3.5 \text{ kA}$

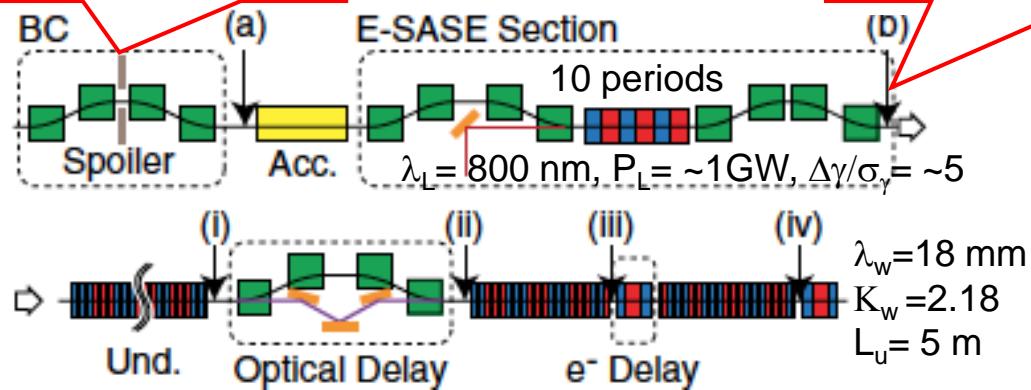

This scheme enables 1) **high peak laser power up to several TW** and 2) **pure single attosecond XFEL pulse**
Demerit: too complicated system

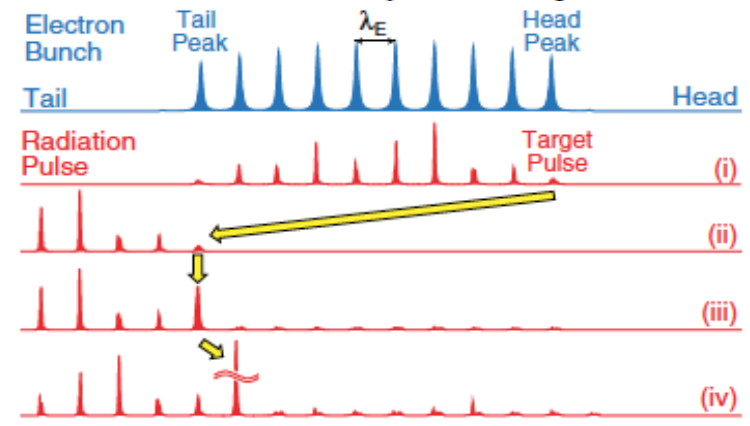

- Generating a series of electron density spikes by a ESASE process with slotted foil
- Generating a seed laser by a undulator radiator
- Adjusting seed laser timing to the tail electron peak
- Enhancing seed laser intensity
- Adjusting the next upstream peak timing to seed laser

Hard bunch compression scheme

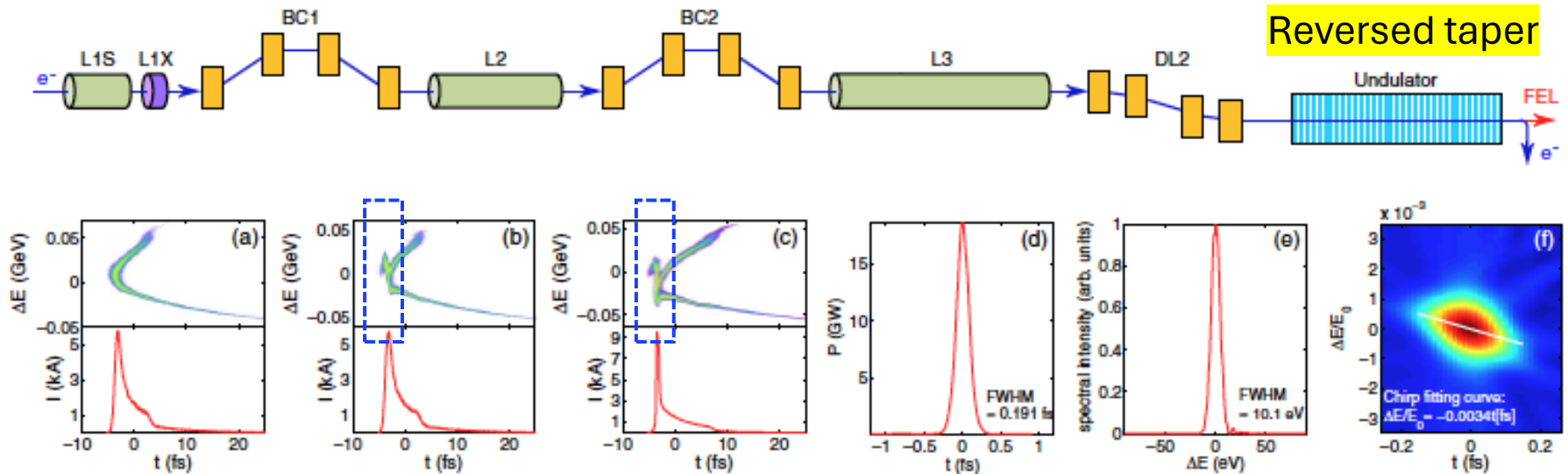

- Low charge of 20 pC -> **difficult to access high peak power**
- Nonlinear hard bunch compression -> peaky peak
- Shortening XFEL pulse by limiting lasing only at the reverse chirp part by using the undulator reverse taper

Scheme using a reverse-chirp due to a space charge force

Additional bunch compression with positive R56

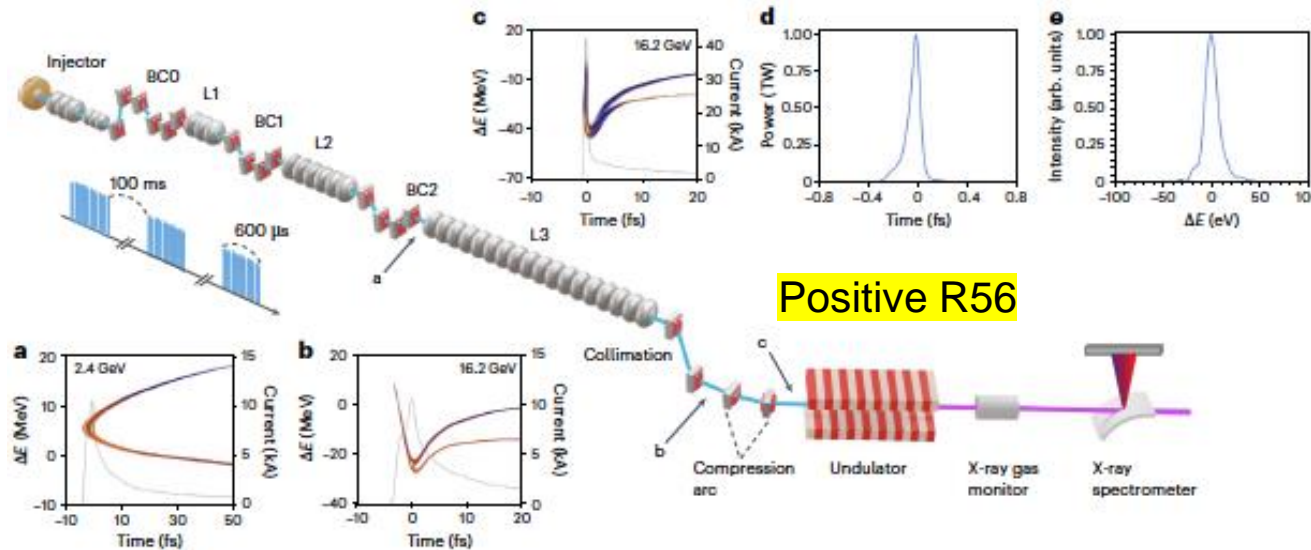

Positive R56

Normal energy chirp Reverse energy chirp

- Self-energy chirp modulation due to SPC -> rather stable operation
- Reverse-energy chirped electron bunch compressed using a positive R56 dogleg
- Small emittance degradation by bunch compression at higher electron energy
- Not optimized dogleg-> **difficult accelerator parameter tuning**

Scheme counteracting the slippage effect towards “single attosecond pulse”

Limit of FEL pulse length determined by a period number of “radiator”
 How do we generate a shorter-pulsed, single attosecond FEL?

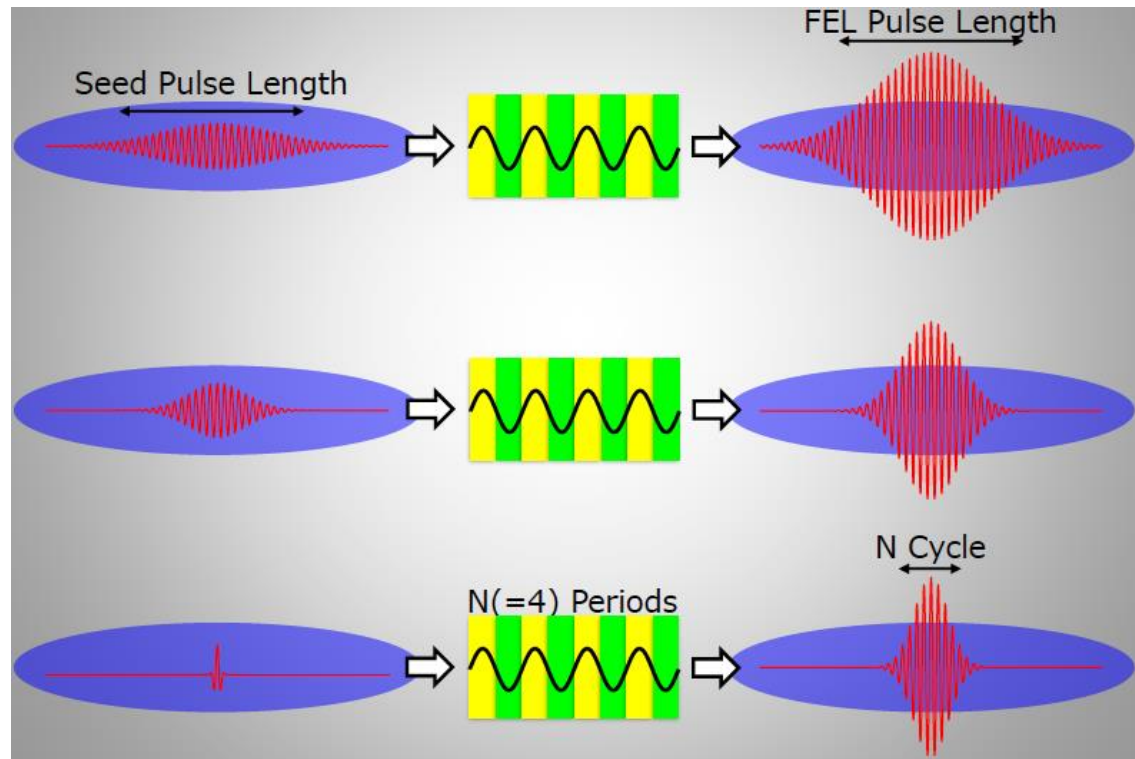

Scheme counteracting the slippage effect towards “single attosecond pulse”

- Chirped micro-bunching with the separation varied from λ_1 to λ_{10}
- Ten period tapered undulator with the slippage changing from λ_1 to λ_{10}
- Dramatic pulse shortening effect by the phase cancellation

Chirped micro-bunching beam

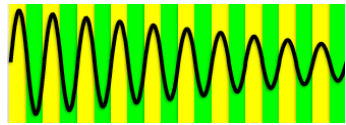

10 period tapered undulator with slippages of $\lambda_1, \lambda_2, \lambda_3 \dots \lambda_{10}$

Radiation from #1

Radiation from #1+2

Radiation from #1+2+3

Radiation from #1+2+3+4

Radiation from #1+2+3+4
.....+10

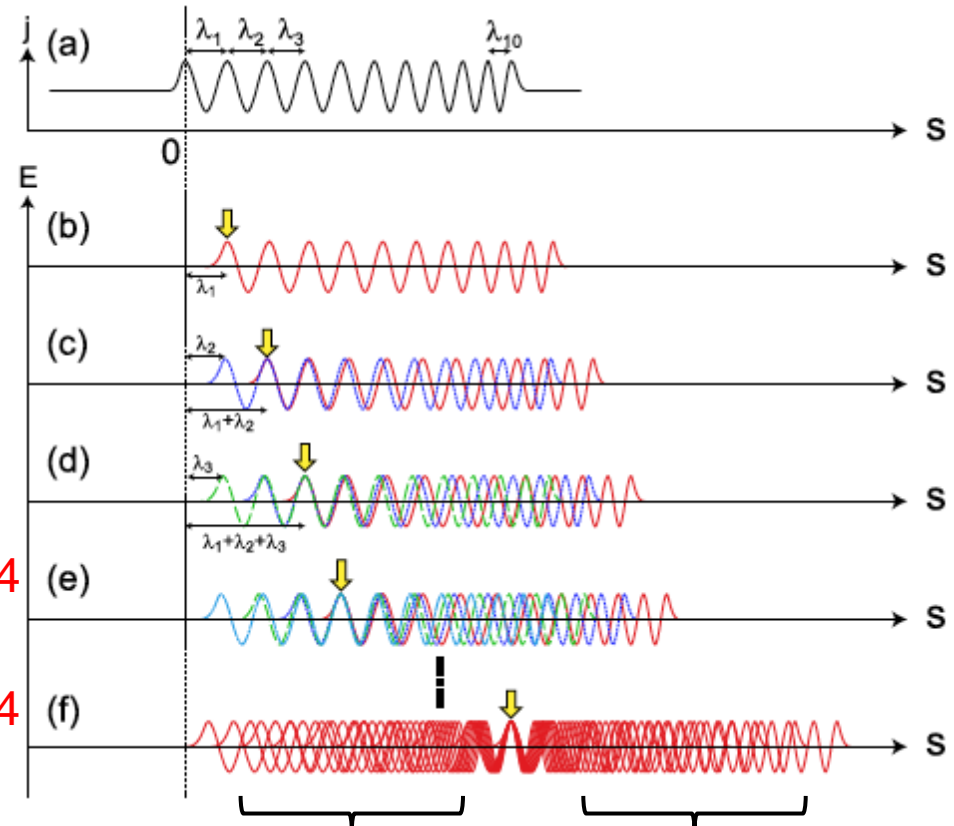

Damped by phase cancellation 45

Scheme counteracting the slippage effect towards “single attosecond pulse”

Generating single cycle density modulation

